



LEVOLOR®

custom
metal blinds



includes:

- metal msrp
- contract customer service manual

contract dealer guide
effective april, 2007

Table of Contents

Contract Customer Service	3
Quotations	4
Who Can Get A Quotation?	4
How To Request A Quotation And How To Place An Order	4
How Fast Can I Get A Quotation?	4
Customer Service Policies	5
Addendum To An Order	5
Air Shipments	5
Bracket Pre-Shipment	5
Changes And Cancellations	5
Contract Order Forms	5
Custom Order Blinds	5
Damaged Or Missing Blinds	6
Defective Blinds At The Jobsite	6
Discontinued Colors, Fabrics Or Products	6
Factory Deductions	6
Missing Parts Policy	7
Oversize / Undersize Blinds	7
Repairs	7
Repricing	7
Return Authorization	7
Rush Programs	7
Split Shipments	8
Trip charges	8
Waivers	8
Concealed Shortages and/or Damages	8
Warranties	9
Metal Blinds	9
Contract Quote Terms & Conditions	10
Contract Metal Collection	11
Color Index	12

Table of Contents (Continued)

Pricing

Mark I 1 $\frac{3}{8}$ " (Cordless)	13
Mark I 1 $\frac{3}{8}$ "	13
Mark I 1 $\frac{3}{8}$ " Options	14
Mark I LightMaster™ (Cordless)	15
Mark I LightMaster™	15
Mark I (Cordless)	16
Mark I	16
Mark I Options	17
Riviera Classic 1" LightMaster™	18
Riviera Classic 1"	18
Riviera Classic 1" Options	19
Riviera Contract 1"	20
Riviera Contract 1" Options	20
Riviera® 2"	21
Riviera® 2" Options	21
Riviera® ½"	22
Riviera® ½" Options	22
Monaco® 6 1" LightMaster™	23
Monaco® 6 1"	23
Monaco® 6 1" Options	24
Riviera® Specialty Metal Blinds	25-31
Incline and Skylight	26
A-Frame or Double Taper, Top Wider	27
Arch or Half-Arch	28
Circle, Oval or Polygon	29
Triangle or Taper, Bottom Wider and Taper, Top Wider	30
Double Taper, Bottom Wider and Top Down/Bottom Up	31

Product Guide

Features and Options	32-33
Blind Options	34
How to Measure / Minimum Mounting Depth	35
Care Instructions	35
How to Make a Template	36
Specifications	37
Exploded View - Mark I 1" and Mark I 1 $\frac{3}{8}$ "	38
Exploded View - Riviera® Classic 1" and Riviera® Contract 1"	39
Exploded View - Riviera® 2"	40
Exploded View - Riviera® ½"	41
Exploded View - Monaco® 6	42
Terms and Conditions	43
Lifetime Limited Warranty	44

Contract Customer Service

The Levolor Contract Customer Service Department is open between the hours of 8:00AM and 7:00PM Eastern Standard Time. Our customer service representatives will be happy to assist you with information, quotes, and orders for the following contract metal products.

- Levolor Brand Metal Horizontal Blinds
- Levolor Brand Specialty Metal Horizontal Blinds

Please note, Levolor wood blinds, NuWood™, faux wood blinds, and verticals (LXT2000 and Zirlon models) are available for contract quotes.

To contact Levolor Contract Customer Service:

Call (800) 826-8021

Fax (800) 624-0029

Orders can be mailed to:

Levolor Kirsch Window Fashions Customer Service

4110 Premier Drive

High Point, NC 27265

www.levolorcontract.com

www.levolor.com

Quotations

Who Can Get A Quotation?

Anyone with a valid Levolor Kirsch Account number.

How To Request A Quotation And How To Place An Order

To ensure correct quoting and ordering, please use the Levolor Contract Order Form to place all orders. Please have the following information available when requesting a quotation or placing an order by telephone, or include it on your Levolor Contract Order Form with your faxed or mailed-in orders:

- Account number
- Purchase order number and/or quotation number (must provide)
- Sold-to address, ship-to address
- Zip code (most important)
- Name of person calling/ordering
- Product (type of window covering)
- Quantity
- Description
- Width
- Length
- Color number and color name
- Control positions
- Special product options e.g., Top-Loks, Tiltone colors
- Special packaging instructions
- Inside or outside mount

How Fast Can I Get A Quotation?

Standard Metal Horizontal Blinds, Wood/Faux Wood Blinds, and Vertical Blinds:

- Phone request: Instant response
- Fax request: Within 24 hours

Specialty Products: Special shapes and sizes (a template may be required)

- Phone or fax requests: Some products can be quoted instantly. If engineering or manufacturing approval is required, we will make every attempt to respond within 24 hours.

Customer Service Policies

Addendum To An Order

All quotations expire 90 days from the original date of quotation.

If you place your order prior to the expiration date of the quotation and then need additional blinds after the order ships, you may order up to 10% of your original order at the same square-foot price plus a 15% surcharge. An addendum order must be placed within 120 days of the original shipment. You must provide the original Levolor Contract order number when placing your order for the addendum.

Air Shipments

Air shipments are at the customer's expense. Requests MUST be in writing to the Levolor Contract Customer Service Department.

Bracket Pre-Shipment

Many contract customers request pre-shipment of brackets so they can begin installation while the blinds are in production. This saves not only time, but also is a much easier installation when blinds arrive. Preshipment of the brackets can be requested by noting on your Levolor Contract order form.

Changes And Cancellations

It is extremely important that each order be checked for accuracy before placing it with Levolor Contract Customer Service. Changes and cancellations will not be accepted after 24 hours from receipt of order. All changes and cancellations MUST be in writing to Levolor Contract Customer Service. A phone call to the Customer Service Representative will get the process started, but your change or cancellation must be confirmed in writing. Once an order is on the production floor, no changes can be made.

Contract Order Forms

Levolor Contract Order Forms are available for horizontal blind orders. Using this form to fax or mail in your order will allow us to process your order quickly and accurately. You may request copies of the Contract Order Form from Levolor Contract Customer Service or through your Levolor sales representative. See back cover for a copy.

Orders not submitted on the Levolor Contract Order Form may be delayed in processing.

Custom Order Blinds

• Horizontals:

Levolor Contract offers a custom color option for metal blinds, whether it is a competitor's color, a discontinued Levolor color, or to match another building color. There is a one-time set up charge of \$250 for each custom color. The minimum requirements for a custom-color quote are:

- 36,000 linear feet of slat
- 2,000 linear feet of headrail and bottomrail

Custom color installation brackets are supplied; however, standard color cord, ladder and other components are used. We require you choose a standard color cord and ladder before producing a mock-up blind for approval. We will paint all materials one time even if split-shipments are requested. Addendums for custom color orders will be filled with any existing material left over from the original run at the regular addendum price. If there is no custom color material left over the addendum price will include the minimum 36,000 linear feet of slat. Please make sure all

windows are measured and extra stock is submitted with the original order so you can avoid this additional

Customer Service Policies (continued)

expense.

Damaged Or Missing Blinds

Do not refuse a damaged shipment – accept it regardless of the condition, but sign for it as damaged. If you receive the shipment as damaged we can enter the remake at a charge and credit the damaged blinds.

If blinds are damaged in transit, but some of the shipment is received intact, you must still sign "damaged" on the trucker's document so we can file a claim with the carrier. Keep the damaged blinds in their original boxes, packing material intact, separate for investigation by the trucking company. Then call Levolor Contract Customer Service to explain your problem and order blinds to replace those that are damaged.

On missing blinds, you must count the packages received before signing the trucker's receipt. Then call Levolor Contract Customer Service to receive a no-charge replacement for the missing blinds.

If the receipt is signed "complete" we have no way of placing a claim with the carrier for the missing blinds.

PLEASE make sure you count your packages before signing. All claims for damaged blinds MUST be reported within 14 days from the original shipment date in order to file a claim with the carrier.

Before sending installers to a remote job site, please check for missing blinds, parts or brackets to avoid unnecessary trip charges. If you encounter concealed damage, call Levolor Contract Customer Service for further instructions. See page 8 for concealed damage policy.

Defective Blinds At The Job Site

If you find that you have several defective blinds when the installation is taking place, call the Levolor Contract Customer Service Department and notify them of the problem. If it is a Levolor Kirsch error, we may ask you to return one blind to us for inspection.

We realize you want to finish your installation and we will accommodate you by ordering additional blinds, at a charge, to be credited when the defective blinds are returned. If the entire order is defective the following steps will be taken:

1. A Levolor sales representative in your area will inspect the blinds at the job site.
2. We will then determine if repairs will be made by Levolor personnel or by the customer. For customer repairs, you will be advised of the pre-approved credit allowable. Levolor Contract Customer Service must give an approval of the exact amount before the actual work takes place.

NOTE: ALL DEFECTIVE BLINDS MUST BE REPORTED WITHIN 90 DAYS FROM THE ORIGINAL SHIPMENT DATE.

Discontinued Colors, Fabrics, Or Products

Inventory is usually available up to 45 days from the date the color, fabric or product was discontinued. However, if the inventory has been depleted prior to 45 days, no other inventory will be painted or procured. If you want to order a discontinued color, fabric or product and there is no material available, that color or fabric is then considered a custom finish (see Custom Order Blinds).

Factory Deductions

Levolor Kirsch will take standard factory deductions on all horizontal blinds unless otherwise indicated on your order. Please reference page 37 for standard deductions

If you write "exact size" on your order no deductions will be taken. Be aware that no deductions (even for brackets)

Customer Service Policies (continued)

will be taken if you write this on your order.

Missing Parts Policy

When you call in a missing parts order, you must have the Levolor order number. Missing parts orders are usually shipped within 48 hours from when you place the order. Levolor will "second day air" the missing parts ONLY upon request. ALL MISSING PARTS MUST BE REPORTED WITHIN 90 DAYS FROM THE ORIGINAL DATE OF SHIPMENT.

Oversize / Undersize Blinds

Although we do not recommend oversize or undersize blinds, we will try to accommodate your request if it does not present a safety hazard or does not impede the function of the product. You will be asked to sign a warranty waiver on any blinds produced outside our recommended parameters.

Contact Levolor Contract Customer Service or your sales representative for specifics.

Repairs

See *Return Authorization*. Repairs are usually shipped out in 7-10 working days.

Repricing

At the time of your quotation we realize that you may not have the exact sizes for a project, which could result in a change to your price once final measurements are made. For this reason we do have a repricing policy.

If your order does not match your quote, it is repriced and the new price is faxed to you with an order confirmation sheet. The new pricing must be reviewed, approved and signed before the blinds are entered as an order and put into production. Delay in the return of this confirmation will result in a delay in production. We cannot be responsible for price differences you have approved.

Return Authorization

No blinds will be accepted at any plant without a Return Authorization (RA) Number from Levolor. This number can be obtained from the Levolor Contract Customer Service Department.

If the problem is a Levolor Kirsch error, a call tag will be issued at no charge to you. Our carrier will pick up the blinds, deliver to the plant for repair, and then ship them back to you. If the problem is a customer error, we will repair the blinds but you will be charged for the repair and for the freight.

Rush Programs

72-HOUR RUSH:

It is EXTREMELY difficult to process 72-hour rushes for contract orders, often due to the order quantity, but we will make every attempt to accommodate you.

A call to Levolor Contract Customer Service starts the process. The CSR first must check inventory and get a commitment from manufacturing. A confirmation from you, in writing, approving the rush charges will be necessary before an order will be processed. Twenty-five (25) blinds or less can be processed as a 72-hour rush, provided we have the material, the plant's commitment, and after CREDIT APPROVAL. The surcharge is \$10 per unit for metal horizontals and \$20 per unit for woods.

5-DAY RUSH:

Five-day rushes are more common for larger orders, but the process is the same for 72-hour rushes. The

Customer Service Policies (continued)

surcharge is \$10 per unit for metal horizontals and \$20 per unit for woods.

Split Shipments

When you receive a quotation from Levolor Contract, it is based on "one lot shipment to one destination." Circumstances may require that the order be placed and shipped in "split shipments."

When you must accommodate your customer by requesting a split shipment, the following procedures are required:

1. Split Shipment requests should be directed to your Levolor sales representative. Please provide the Project Name, number and size of shipments or parts requested, and estimated completion dates.
2. Split Shipment orders must match the quantity and sizes of the original quotation. Size deviations will require a revised quotation.
3. All blinds must be ordered within 6 months of the first order date.
4. Quotations must be split based on the following guidelines:
 - a. 500 blinds or less: all orders must be a minimum of 50 blinds
 - b. 501 to 1,000 blinds: all orders must be a minimum of 100 blinds
 - c. 1,001 blinds or more: all orders must be a minimum of 250 blinds
5. You must send in the first order with the quotation number noted on it so the order is priced correctly. Mark the order "Part 1 of (number of parts)."

Trip Charges

Please contact your Levolor sales representative for trip charge approval. Please provide the sales representative with the order number, information on the reason for the trip and the estimated amount of the trip charge. If you submit a trip charge WITHOUT PRIOR APPROVAL, it will be denied.

Waivers

When we produce a blind outside of our standard manufacturing parameters, we do ask you to sign a waiver, which will be provided at the time you place the order. This waiver voids any warranty on that blind. Any waiver requirements will be noted on your quote.

Concealed Shortages and/or Damages

Defective or missing product claims must be submitted within 90 days from receipt of original shipment. Claims submitted after 90 days may be denied. Claims received after 180 days will not be accepted. Submit claims by fax to Levolor Contract Customer Service at 800-624-0029.

Warranties

Metal Blinds

The following warranty terms apply:

- All Levolor Riviera®, Mark I and Monaco® 6 Blinds – Limited Lifetime Warranty

Levolor will repair or replace, without charge, any part found defective in workmanship or material, exclusive of labor, for the term of the product warranty as long as the blind remains in the same window for which it was purchased. This warranty applies only to manually operated, horizontal aluminum blinds (excluding blinds manufactured under a warranty waiver). It does not, however, cover damage caused by cleaning methods that utilize abrasive solutions or ultrasonic equipment. It does not cover damage caused by misuse, abuse, direct exposure to salty air, chemical fumes, extremes in humidity or the color change that will take place with the passage of time.

Contract Quote Terms & Conditions

a) Quote Expiration Date

90 days from date of original quotation.

b) Quote Extension

Must be approved by your Levolor sales representative.

c) Inspection & Acceptance Policy

Claims must be made within 90 days from the date the original shipment took place.

d) Lot Shipment

All quotations are based upon a single lot shipment. Any special services such as storage, advanced or partial shipments, or movement of Levolor material beyond the point where a common carrier can execute delivery will be at customer's expense. Subsequent requests which vary from this, when a purchase order is placed to and accepted by Levolor Contract, may result in additional charges. Such additional charges and terms for split shipments must be agreed to in writing prior to the original actual shipment and will be clearly stated on the customer's purchase order followed by a revised quotation being issued including the stated shipment terms.

e) Quote Size and Deviation Adjustment

The original purchase order must reference the original contract quotation number, quotation date, the total number of blinds, the sizes involved and the quoted price. Any deviations outlined in the purchase order, e.g. blind quantities, sizes and/or colors quoted which change the quoted dollar amount by more than one-half percent (0.5%) will require a new quotation.

f) Fill-In Order (Addendum) Policy

All quotations expire 90 days from the original quotation date. If you place an order prior to the quote expiration date and then need additional blinds after the order ships, the following applies:

- You may order up to 10% of the original order in the same color as the quotation
- The addendum order is priced at the same square foot price as the original quotation, plus a 15% surcharge
- Addendum orders must be placed within 90 days of the original shipment
- The original Levolor order number is required to place the addendum order
- Undersize or oversize blinds will be priced with the respective upcharge, as well as the 15% surcharge

g) Other Terms & Conditions

All purchase orders are subject to the terms and conditions set out on the reverse side of the quotation form. Levolor Contract hereby rejects any disclaimer of said terms and conditions. Any terms submitted by the customer which attempt to vary or modify said terms is rejected, void and of no effect.

Levolor Contract Metal Collection

Mark I Collection (Integrated headrail and concealed mounting bracket collection)

Mark I 1 3/8"

- Available Cordless (MARK138C)
- Available with Traditional Lift System (MARK138)

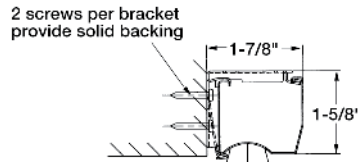
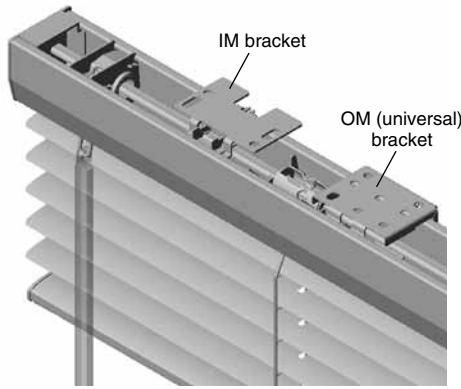

Outside Mounted Detail

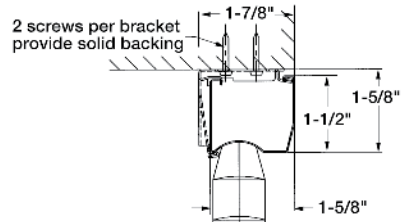

Inside Mounted Detail

Note: Headrail and brackets are the same for both Mark I 1 3/8" and Mark I 1" products.

Mark I

- Available Cordless with LightMaster™ (MARK1CP)
- Available with LightMaster™ (MARK1P)
- Available Cordless - Standard Route Holes (MARK1C)
- Available with Traditional Lift System (MARK1)

Riviera® Collection (Box bracket collection)

- Riviera Classic 1" (RIV1)
- Riviera Classic 1" LightMaster™ (RIV1P)
- Riviera 1" Contract (RIV1C)
- Riviera 2" (RIV2)
- Riviera 1/2" (RIV12)
- Riviera Specialties (RIV1-S)

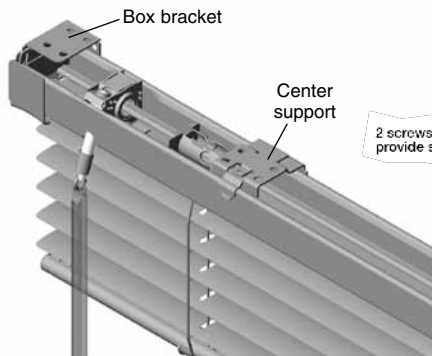

Model Shown: Riviera Classic 1"

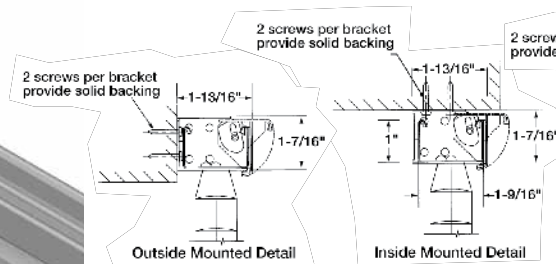

Note: Bracket detail for RIV1, RIV1P, RIV1C, RIV1-S

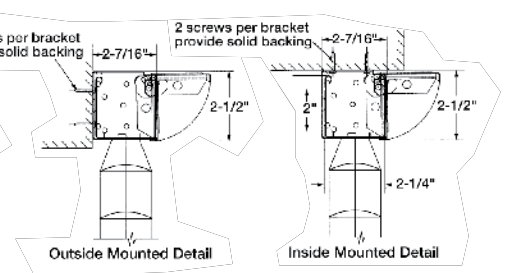

Note: Bracket detail for RIV2

Monaco® 6 Collection (Available with box brackets or concealed brackets*)

- Monaco® 6 LightMaster™ (MON6P)
- Monaco® 6 Traditional Route Holes (MON6)

*Color coordinated box brackets are standard for contract orders.

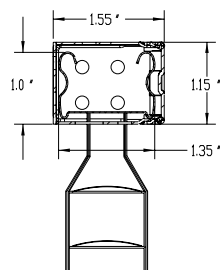
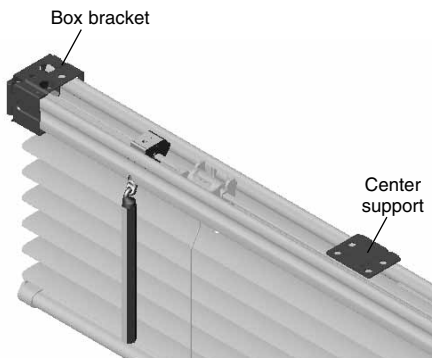

Box Bracket Detail

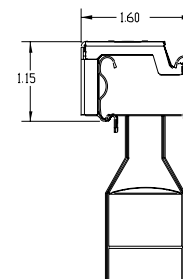

Integrated Bracket Detail

Color Index

Color #	Description	*Mark I 1" Riviera® Classic 1"	**Mark I 1½"	Riviera® Contract 1" ***Monaco® 6	Riviera® 2"	Riviera® ½"
Solid Finishes						
110	White	■	■	■	■	■
111	Cotton	■	■	■	■	■
112	Alabaster	■	■	■	■	■
113	White Cap	■	■		■	
115	Dover	■	■	■	■	■
116	Polar Bear	■	■	■	■	■
137	Almond	■	■	■	■	■
148	Vanilla	■	■	■	■	■
201	Ivory	■	■	■	■	■
202	Blush White	■	■	■	■	■
268	Real Red	■	■	■		■
275	Garnet Red	■	■	■		■
292	Gingersnap	■	■		■	
310	Sand	■	■	■	■	■
312	Greige	■	■	■	■	■
316	Malibu Sand	■	■	■	■	■
365	Mushroom	■	■	■	■	■
368	Beacon Brown	■	■			
384	Rich Earth	■	■		■	
571	Cactus Sage	■	■	■	■	■
590	Sherwood Green	■	■	■	■	■
637	China Blue	■	■	■	■	■
641	Evening Shadows	■	■	■		■
685	Royal Navy	■	■	■		■
765	Wood Violet	■	■		■	
815	Birch	■	■		■	
820	Squirrel Gray	■	■	■	■	■
860	Mercury	■	■	■		■
862	Pearl Gray	■	■	■	■	■
870	U.N. Gray	■	■	■	■	■
885	Dark Bronze	■	■	■	■	■
887	Raw Umber	■	■	■	■	■
890	Black	■	■	■	■	■
892	Low Gloss Black	■	■	■	■	■
Pearlescence Finishes						
1388	Vapor	■	■		■	
1389	Golden Mist	■	■		■	
Opulescence Finishes						
1392	Quartz White	■	■		■	
1393	Glazed Bisque	■	■		■	
Metallic Finishes						
31	Satin Nickel	■	■	■	■	■
34	Brushed Aluminum	■	■	■	■	■
915	Copperite	■	■			
968	Ash Bronze	■	■	■	■	■
1440	Cityscape	■	■		■	
1441	Galleria	■	■		■	
1443	Brass	■	■		■	
Native Stone Finishes						
2814	Sandstone	■	■			
2815	Earthstone	■	■			
2826	Canyonstone	■	■			
2828	Claystone	■	■			
Tiltone						
5885	Dark Bronze/Dover	■	■			
SheerView (Available with Cordless Mark I, Mark I, Riviera Classic 1" and Riviera Specialty Shapes)						
34	Brushed Aluminum	■				
110	White	■				
112	Alabaster	■				
885	Dark Bronze	■				
892	Low Gloss Black	■				

*Includes: Cordless Mark I LightMaster™, Mark I LightMaster™, Cordless Mark I, Mark I, Riviera Classic 1" LightMaster™, Riviera Classic 1", Riviera Specialty Shapes
 **Includes: Cordless Mark I 1½", Mark I 1½"
 ***Includes: Monaco® 6, Monaco® 6 LightMaster™

Mark I 1 3/8" Blind

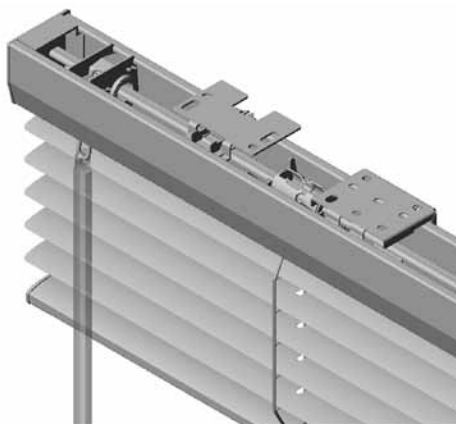

Features

- DustGuard®
- Steel Internal Headrail Components
- Valance-Free Design
- Concealed Mounting System
- Headrail: 1 1/2" High x 1 5/8" Wide with Crowned Underside Profile
- 1 3/8" Slat Width
- 8 Gauge Slat
- Enclosed Bottomrail with Bottom Bumper
- Guardian Tilter Disengaging Clutch Mechanism
- Crash Proof Cordlock
- Available Cordless
- Limited Lifetime Warranty
- 27.5mm Ladder Spacing

Mark I 1 3/8" (Cordless)

(MARK138C)

	Width to																				
	23"	26"	29"	32"	36"	40"	44"	48"	52"	57"	62"	67"	72"	82"	92"	100"	112"	122"	132"	142"	
Height to 42"	268	282	293	307	325	342	360	371	392	434	459	491	519	586	646	734	829	921	1017	1112	
48"	282	289	304	318	346	364	374	395	420	480	508	540	579	646	706	805	900	999	1094	1193	
54"	289	300	311	328	364	392	402	427	455	515	554	586	625	702	776	875	978	1073	1175	1274	
60"	300	307	325	349	381	427	434	459	494	558	589	635	671	762	836	953	1062	1175	1285	1394	
66"	304	321	349	364	392	459	459	501	529	600	635	681	731	812	900	1020	1133	1249	1362	1482	
73"	321	339	367	395	438	480	494	529	568	635	688	731	776	875	964	1091	1218	1345	1475	1602	
	single blind																2 blinds on one headrail				
Premium Finish Surcharge	32			35			42			53			67			92			124		

Shaded area requires multiple blinds per headrail. To price multiple blinds on a headrail, see price above based on overall width then add appropriate surcharge from below.

Mark I 1 3/8" (Traditional Lift Cords)

(MARK138)

	Width to																				
	23"	26"	29"	32"	36"	40"	44"	48"	52"	57"	62"	67"	72"	82"	92"	102"	112"	122"	132"	142"	
Height to 42"	152	169	176	194	215	233	251	272	286	328	342	364	388	438	480	551	674	727	769	819	
48"	169	176	201	208	240	258	279	296	314	357	381	402	427	480	533	600	731	791	844	889	
54"	176	201	215	226	258	279	304	318	339	385	413	438	469	526	579	657	791	854	907	960	
60"	198	208	226	244	272	304	325	342	367	413	441	476	505	568	632	709	847	914	974	1034	
66"	208	222	247	258	293	325	342	378	395	445	480	508	544	607	674	759	900	978	1045	1105	
72"	219	240	258	275	307	342	367	395	424	480	515	544	579	657	720	815	960	1045	1108	1179	
78"	233	258	279	304	335	364	392	424	455	508	544	579	614	695	769	868	1020	1105	1179	1253	
84"	247	272	296	318	357	385	416	445	480	544	579	614	657	741	819	914	1077	1175	1246	1324	
90"	258	286	311	332	378	409	438	476	505	568	607	657	692	784	865	971	1133	1235	1317	1401	
96"	279	304	328	357	395	431	469	501	533	600	642	688	731	826	911	1027	1196	1295	1384	1479	
102"	289	314	342	367	413	455	487	526	561	632	681	720	766	868	964	1077	1249	1359	1458	1560	
108"	307	332	357	388	431	476	515	551	589	660	709	755	805	911	1013	1129	1309	1422	1539	1638	
114"	314	342	378	402	455	498	540	579	614	692	745	794	847	957	1055	1186	1369	1500	1606	1715	
120"	328	357	392	424	476	519	558	604	646	720	773	829	879	999	1105	1239	1426	1564	1677	1782	
126"	339	378	409	438	498	544	582	632	674	752	812	865	925	1045	1151	1288	1500	1627	1747	1860	
Premium Finish Surcharge	25			32			42			53			67			95			124		

Mark I 1³/₈" Blind Options

Colors

Available in all colors - see page 12

Basic Finishes

Solid Base Pricing
Tiltone

Premium Slat Finishes

Pearlescence See Pricing Chart Page 13 for Surcharge
Opulescence See Page 12 for Color Chart
Metallic
Native Stone

Free Options*

Hold-down Brackets

Cordless Control Options:

Tilter Left (Standard)
Tilter Right

Traditional Lift Cord Control Options:

Tilter Left, Lift Cord Right (Standard)
Tilter Right, Lift Cord Left
All Controls Right
All Controls Left

(See page 37 for specifications, including size limitations)

Extension Brackets (Choose from 1¹/₄" or 2³/₄" to 4¹/₄")

Side Mount Brackets (Limited to 48"W x 80"H maximum blind size)

* Must be requested at time of order.

Surcharge Options

Add to the Price of the Blind:

Cordless Options:

Multi-Color Striping:
Each Color (max 6 total) \$40

Multiple Blinds on One Headrail:
2 Blinds per Headrail \$90
3 Blinds per Headrail \$125

Traditional Lift Cord Options:

Blinds 17" in width or less \$35

Multi-Color Striping:
Each Color (max 6 total) \$40

Multiple Blinds on One Headrail:
2 Blinds per Headrail \$90
3 Blinds per Headrail \$125

Cutout Option:

Side Cutout \$50 per side
Center Cutout \$70

Top-Lok Cord Lock \$5
Ring Pull \$20
Restrictive Tilter (see page 35 for options) \$5

Mark I 1" Blind

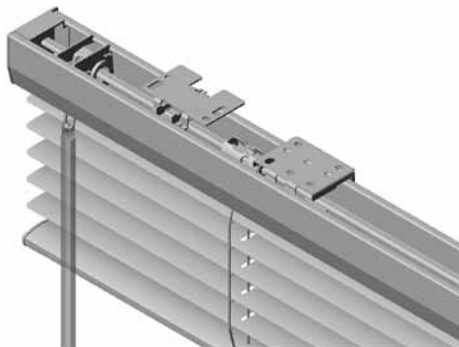

Features

- DustGuard®
- Steel Internal Headrail Components
- Valance-Free Design
- Concealed Mounting System
- Headrail: 1½" High x 1⅝" Wide with Crowned Underside Profile
- 1" Slat Width
- 8 Gauge Slat
- Enclosed Bottomrail with Bottom Bumper
- Guardian Tilter Disengaging Clutch Mechanism
- Crash Proof Cordlock
- Available Cordless
- Available LightMaster™
- Limited Lifetime Warranty
- 21.5mm Ladder Spacing (Standard)
- 19.5mm Ladder Spacing (Upgrade)
- 18mm Ladder Spacing (LightMaster™)

Mark I LightMaster™ (Cordless)

(MARK1CP)

	Width to																			
	23"	26"	29"	32"	36"	40"	44"	48"	52"	57"	62"	67"	72"	82"	92"	100"	112"	122"	132"	142"
Height to 42"	259	271	282	297	313	332	347	358	378	419	442	473	500	564	622	709	801	888	980	1071
48"	271	278	294	305	334	351	362	381	404	461	492	522	557	622	683	778	869	965	1056	1151
54"	278	290	301	316	351	378	389	412	439	496	534	564	602	679	747	843	942	1033	1132	1228
60"	290	297	316	336	370	412	419	442	477	538	568	614	648	736	808	919	1026	1132	1239	1346
66"	297	313	336	351	378	442	442	484	511	580	614	656	705	782	869	984	1094	1205	1315	1430
73"	313	328	355	381	423	461	477	511	549	614	663	705	747	843	930	1052	1174	1296	1422	1544
	single blind																2 blinds on one headrail			
Premium Finish Surcharge	31		34		42			50			65			88			118			

Shaded area requires multiple blinds per headrail. To price multiple blinds on a headrail, see price above based on overall width then add appropriate surcharge from below.

Mark I LightMaster™ (Traditional Lift Cords)

(MARK1P)

	Width to																			
	23"	26"	29"	32"	36"	40"	44"	48"	52"	57"	62"	67"	72"	82"	92"	102"	112"	122"	132"	142"
Height to 42"	145	165	176	191	214	230	249	264	279	322	341	360	383	433	475	544	662	712	758	804
48"	165	176	199	207	237	253	272	291	306	352	375	398	425	475	524	597	716	777	827	873
54"	176	199	214	226	253	272	295	314	337	379	410	433	463	521	574	647	777	838	892	949
60"	199	207	226	237	264	295	318	341	368	410	436	471	498	563	620	697	831	903	961	1018
66"	207	222	245	253	287	318	341	371	390	440	471	502	536	605	666	750	888	961	1030	1087
72"	222	237	256	268	299	341	368	390	417	471	509	536	574	647	708	804	949	1030	1087	1160
78"	230	253	272	295	333	360	387	417	444	502	536	574	609	689	762	858	1003	1087	1160	1233
84"	245	268	291	314	352	379	413	440	475	536	570	609	647	731	808	907	1060	1152	1225	1305
90"	256	279	302	325	371	406	433	471	502	563	605	647	685	773	850	957	1114	1214	1294	1382
96"	272	295	322	352	390	425	463	494	524	597	636	678	720	815	903	1015	1175	1279	1355	1455
102"	283	306	341	368	410	444	482	521	555	624	670	708	762	861	953	1064	1229	1336	1436	1539
108"	299	322	356	383	425	471	509	544	578	651	697	750	796	903	1003	1114	1290	1401	1516	1616
114"	306	341	371	398	448	490	532	570	609	685	735	785	835	946	1041	1171	1344	1478	1585	1688
120"	322	356	387	417	471	513	551	597	639	708	766	815	869	988	1087	1225	1409	1539	1654	1757
126"	337	371	406	433	490	536	578	624	666	743	800	850	911	1030	1141	1275	1474	1604	1719	1838
Premium Finish Surcharge	22		31		42			54			65			92			122			

Mark I (Cordless)

(MARK1C)

Width to	23"	26"	29"	32"	36"	40"	44"	48"	52"	57"	62"	67"	72"	82"	92"	100"	112"	122"	132"	142"
Height to 42"	246	257	268	276	294	309	328	347	361	402	421	451	477	537	592	678	764	850	935	1021
48"	250	261	276	287	324	335	339	361	384	440	470	499	529	592	652	742	835	924	1014	1103
54"	261	268	291	306	335	361	373	391	417	470	511	537	578	648	715	805	898	991	1084	1177
60"	272	287	306	317	343	391	399	421	455	511	544	585	619	701	771	876	973	1077	1177	1278
66"	287	306	317	335	369	421	421	462	488	551	589	626	671	749	831	935	1043	1148	1256	1364
73"	302	313	335	361	406	440	455	488	522	589	633	671	715	805	887	1002	1122	1241	1356	1472
single blind																	2 blinds on one headrail			
Premium Finish Surcharge	26		34			41			48			60			86			116		
SheerView Surcharge	97		112			138			171			212			294			399		
Ladder Upgrade Surcharge	14		16			20			24			31			42			57		

Shaded area requires multiple blinds per headrail. To price multiple blinds on a headrail, see price above based on overall width then add appropriate surcharge from below.

Mark I (Traditional Lift Cords)

(MARK1)

Width to	23"	26"	29"	32"	36"	40"	44"	48"	52"	57"	62"	67"	72"	82"	92"	102"	112"	122"	132"	142"
Height to 42"	142	154	163	179	197	214	231	248	261	301	315	336	359	405	443	507	622	671	712	753
48"	154	163	184	192	221	237	255	272	288	330	351	372	397	443	489	555	674	731	777	819
54"	163	184	198	210	237	256	277	293	312	353	381	405	432	486	534	603	729	785	835	888
60"	183	192	210	229	255	277	300	315	339	382	407	439	464	525	580	655	779	845	901	954
66"	191	208	229	244	274	300	315	348	364	412	440	468	501	560	622	700	831	903	962	1020
72"	204	222	239	258	289	314	339	364	391	440	475	502	534	603	663	750	888	962	1022	1087
78"	214	237	256	277	309	335	362	391	416	468	502	534	566	643	710	798	938	1019	1087	1156
84"	229	249	272	293	330	353	383	412	442	500	533	566	603	684	752	845	994	1082	1151	1222
90"	239	261	285	307	349	379	406	439	465	525	560	602	638	721	797	897	1045	1137	1214	1293
96"	255	277	302	328	364	398	432	460	490	555	592	634	675	762	841	945	1104	1196	1273	1363
102"	267	289	314	339	382	416	448	486	519	582	627	663	709	801	889	993	1153	1253	1343	1439
108"	281	303	331	359	400	439	475	508	545	607	655	697	743	841	933	1043	1209	1310	1419	1512
114"	289	315	349	372	417	458	498	533	566	638	685	734	779	882	972	1093	1261	1385	1483	1578
120"	302	331	361	391	439	477	516	557	594	663	714	764	812	922	1017	1143	1316	1441	1546	1644
126"	312	349	378	406	458	500	538	581	622	692	746	797	852	962	1061	1190	1384	1500	1610	1716
Premium Finish Surcharge	22		30			37			49			63			86			116		
SheerView Surcharge	82		105			134			172			217			302			403		
Ladder Upgrade Surcharge	12		15			19			24			31			43			58		

Mark I 1" Blind Options

Colors

Available in all colors - see page 12

Basic Finishes

Solid
Tiltone

Base Pricing

Premium Slat Finishes

Pearlescence See Pricing Pages 15-16 for Surcharge
Opulescence See Page 12 for Color Chart
Metallic
Native Stone
SheerView

Free Options*

Hold-down Brackets

Cordless Control Options:

Tilter Left (Standard)
Tilter Right

Traditional Lift Cord Control Options:

Tilter Left, Lift Cord Right (Standard)
Tilter Right, Lift Cord Left
All Controls Right
All Controls Left

(See page 37 for specifications, including size limitations)

Extension Brackets (Choose from 1¼" or 2¾" to 4¼")

Side Mount Brackets (Limited to 48"W x 80"H maximum blind size)

* Must be requested at time of order.

Surcharge Options

Add to the Price of the Blind:

Cordless Options:

Multi-Color Striping:
Each Color (max 6 total) \$40

Multiple Blinds on One Headrail:
2 Blinds per Headrail \$90
3 Blinds per Headrail \$125

Traditional Lift Cord Options:

Blinds 17" in width or less \$37

Multi-Color Striping:
Each Color (max 6 total) \$40

Multiple Blinds on One Headrail:
2 Blinds per Headrail \$90
3 Blinds per Headrail \$125

Cutout Option:

Side Cutout \$50 per side
Center Cutout \$70

Top-Lok Cord Lock** \$5
Ring Pull \$20
Restrictive Tilter** (see page 33 for options) \$5
Ladder Upgrade (19.5mm ladder) see pricing chart pages 15-16

**Not available with LightMaster™

Riviera® Classic 1" Blind



Features

- DustGuard®
- Steel Internal Headrail Components
- Valance Available
- Headrail: 1" High x 1 1/16" Wide
- 1" Slat Width
- 8 Gauge Slat
- Guardian Tilter Disengaging Clutch Mechanism
- Crash Proof Cordlock
- Available LightMaster™
- Limited Lifetime Warranty
- 21.5mm Ladder Spacing (Standard)
- 19.5mm Ladder Spacing (Upgrade)
- 18mm Ladder Spacing (LightMaster™)

Riviera Classic 1" LightMaster™

(RIV1-P)

Width to	23"	26"	29"	32"	36"	40"	44"	48"	52"	57"	62"	67"	72"	82"	92"	102"	112"	122"	132"	142"
Height to 42"	145	165	176	191	214	230	249	264	279	322	341	360	383	433	475	544	662	712	758	804
48"	165	176	199	207	237	253	272	291	306	352	375	398	425	475	524	597	716	777	827	873
54"	176	199	214	226	253	272	295	314	337	379	410	433	463	521	574	647	777	838	892	949
60"	199	207	226	237	264	295	318	341	368	410	436	471	498	563	620	697	831	903	961	1018
66"	207	222	245	253	287	318	341	371	390	440	471	502	536	605	666	750	888	961	1030	1087
72"	222	237	256	268	299	341	368	390	417	471	509	536	574	647	708	804	949	1030	1087	1160
78"	230	253	272	295	333	360	387	417	444	502	536	574	609	689	762	858	1003	1087	1160	1233
84"	245	268	291	314	352	379	413	440	475	536	570	609	647	731	808	907	1060	1152	1225	1305
90"	256	279	302	325	371	406	433	471	502	563	605	647	685	773	850	957	1114	1214	1294	1382
96"	272	295	322	352	390	425	463	494	524	597	636	678	720	815	903	1015	1175	1279	1355	1455
102"	283	306	341	368	410	444	482	521	555	624	670	708	762	861	953	1064	1229	1336	1436	1539
108"	299	322	356	383	425	471	509	544	578	651	697	750	796	903	1003	1114	1290	1401	1516	1616
114"	306	341	371	398	448	490	532	570	609	685	735	785	835	946	1041	1171	1344	1478	1585	1688
120"	322	356	387	417	471	513	551	597	639	708	766	815	869	988	1087	1225	1409	1539	1654	1757
126"	337	371	406	433	490	536	578	624	666	743	800	850	911	1030	1141	1275	1474	1604	1719	1838
Premium Finish Surcharge	22		31			42			54			65			92			122		

Riviera Classic 1"

(RIV1)

Width to	23"	26"	29"	32"	36"	40"	44"	48"	52"	57"	62"	67"	72"	82"	92"	102"	112"	122"	132"	142"
Height to 42"	142	154	163	179	197	214	231	248	261	301	315	336	359	405	443	507	622	671	712	753
48"	154	163	184	192	221	237	255	272	288	330	351	372	397	443	489	555	674	731	777	819
54"	163	184	198	210	237	256	277	293	312	353	381	405	432	486	534	603	729	785	835	888
60"	183	192	210	229	255	277	300	315	339	382	407	439	464	525	580	655	779	845	901	954
66"	191	208	229	244	274	300	315	348	364	412	440	468	501	560	622	700	831	903	962	1020
72"	204	222	239	258	289	314	339	364	391	440	475	502	534	603	663	750	888	962	1022	1087
78"	214	237	256	277	309	335	362	391	416	468	502	534	566	643	710	798	938	1019	1087	1156
84"	229	249	272	293	330	353	383	412	442	500	533	566	603	684	752	845	994	1082	1151	1222
90"	239	261	285	307	349	379	406	439	465	525	560	602	638	721	797	897	1045	1137	1214	1293
96"	255	277	302	328	364	398	432	460	490	555	592	634	675	762	841	945	1104	1196	1273	1363
102"	267	289	314	339	382	416	448	486	519	582	627	663	709	801	889	993	1153	1253	1343	1439
108"	281	303	331	359	400	439	475	508	545	607	655	697	743	841	933	1043	1209	1310	1419	1512
114"	289	315	349	372	417	458	498	533	566	638	685	734	779	882	972	1093	1261	1385	1483	1578
120"	302	331	361	391	439	477	516	557	594	663	714	764	812	922	1017	1143	1316	1441	1546	1644
126"	312	349	378	406	458	500	538	581	622	692	746	797	852	962	1061	1190	1384	1500	1610	1716
Premium Finish Surcharge	22		30			37			49			63			86			116		
SheerView Surcharge	82		105			134			172			217			302			403		
Ladder Upgrade Surcharge	12		15			19			24			31			43			58		

Riviera® Classic 1" Blind Options

Colors

Available in all colors - see page 12

Basic Finishes

Solid
Tiltone

Base Pricing

Premium Slat Finishes

Pearlescence
Opulescence
Metallic
Native Stone
Sheer View

See Pricing Chart Page 18 for Surcharge
See Page 12 for Color Chart

Free Options*

2 Slat Framed Vogue Valance for Retail Orders (Surcharge applies for contract quotes)

Hold-down Brackets

Control Options:

Tilter Left, Lift Cord Right (Standard)
Tilter Right, Lift Cord Left
All Controls Right
All Controls Left

(See page 37 for specifications, including size limitations)

Extension Brackets (Choose from 1¼" or 2¾" to 4¼")

Side Mount Brackets (Limited to 48"W x 80"H maximum blind size)

* **Must be requested at time of order.**

Surcharge Options

Add to the Price of the Blind:

Blinds 17" in width or less	\$37
Multi-Color Striping: Each Color (max 6 total)	\$40
Multiple Blinds on One Headrail: 2 Blinds per Headrail 3 Blinds per Headrail	\$90 \$125
Cutout Option**: Side Cutout Center Cutout	\$50 per side \$70
Top-Lok Cord Lock** Ring Pull Restrictive Tilter** (see page 33 for options) Ladder Upgrade Surcharge	\$5 \$20 \$5 see pricing chart page 18
Additional or Separate Vogue Valance (2 Slat standard valance available upon request for contract quotes)	\$75

**Not available with LightMaster™

Riviera® Contract 1" Blind

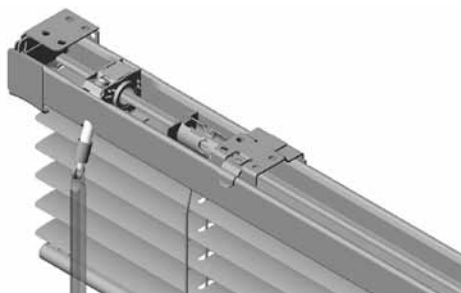

Features

- DustGuard®
- Steel Internal Headrail Components
- Headrail: 1" High x 1 1/16" Wide
- 1" Slat Width
- 6 Gauge Slat
- Guardian Tilter Disengaging Clutch Mechanism
- Crash Proof Cordlock
- Limited Lifetime Warranty
- 21.5mm Ladder Spacing

Riviera® 1" Contract

(RIV1C)

Width to	23"	26"	29"	32"	36"	40"	44"	48"	52"	57"	62"	67"	72"	82"	92"	102"	112"	122"	132"	142"
Height to 42"	118	132	146	161	175	189	203	217	231	274	288	307	331	368	411	461	578	610	661	685
48"	132	146	161	170	194	208	227	241	255	302	317	340	354	411	449	515	619	679	714	760
54"	146	161	175	184	208	227	246	260	274	321	345	368	387	444	487	551	665	718	762	812
60"	161	170	184	203	227	246	265	279	298	350	373	402	425	482	529	602	711	776	822	876
66"	170	184	198	217	241	260	279	307	321	373	402	430	458	515	572	644	765	831	885	939
72"	179	194	208	231	255	279	307	321	345	402	430	458	487	543	609	676	816	867	939	979
78"	189	208	227	246	274	298	321	345	368	425	458	487	520	586	647	728	855	929	991	1054
84"	203	217	241	255	293	312	340	364	392	453	487	515	548	624	690	771	913	988	1057	1115
90"	208	231	255	274	307	331	359	392	411	482	515	543	586	661	723	823	948	1043	1102	1186
96"	227	250	269	288	321	350	378	406	439	505	538	576	614	694	770	861	1011	1090	1166	1242
102"	238	261	280	298	337	366	392	429	465	530	570	603	645	730	814	905	1056	1142	1230	1311
108"	251	274	295	316	353	387	416	449	489	553	596	634	676	766	855	950	1107	1194	1300	1378
114"	258	285	311	327	368	403	436	471	508	581	623	667	709	804	890	996	1155	1262	1358	1438
120"	269	299	322	344	388	420	452	492	533	604	649	695	739	840	932	1041	1205	1313	1416	1498
126"	278	315	337	357	404	440	471	513	558	630	678	725	776	877	972	1084	1268	1367	1475	1563
Premium Finish Surcharge	21		26			34			44			56			79			106		

Colors

Available in all colors - see page 12

Basic Finishes

Solid
Tiltone

Base Pricing
Base Pricing

Premium Slat Finishes

Pearlescence
Opulescence
Metallic
Native Stone
Sheer View

See Pricing Chart Above for Surcharge
See Page 12 for Color Chart

Free Options*

2 Slat Framed Vogue Valance for Retail Orders (Surcharge applies for contract quotes)

Hold-down Brackets

Control Options:

- Tilter Left, Lift Cord Right (Standard)
- Tilter Right, Lift Cord Left
- All Controls Right
- All Controls Left

(See page 37 for specifications, including size limitations)

Extension Brackets (Choose from 1 1/4" or 2 3/4" to 4 1/4")

Side Mount Brackets (Limited to 48"W x 80"H maximum blind size)

* Must be requested at time of order.

Surcharge Options

Add to the Price of the Blind:

Blinds 17" in width or less	\$47
Multi-Color Striping: Each Color (max 6 total)	\$40
Multiple Blinds on One Headrail: 2 Blinds per Headrail	\$90
3 Blinds per Headrail	\$125
Cutout Option: Side Cutout	\$50 per side
Center Cutout	\$70
Top-Lok Cord Lock	\$5
Ring Pull	\$20
Restrictive Tilter (See page 33 for options)	\$5
Additional or Separate Vogue Valance	\$75

(2 Slat standard valance available upon request for contract quotes)

Riviera® 2" Blind



Features

- DustGuard®
- Headrail: 2⁵/₁₆" High x 2¹/₄" Wide with Crowned Underside Profile
- 2" Slat Width
- 9 Gauge Slat
- Optional Vinyl or Fabric Twill Tapes
- Optional Heavy Duty C90 Cord
- Limited Lifetime Warranty
- 44mm Ladder Spacing

Riviera 2"

(RIV2)

Height to	Width to																			
	23"	26"	29"	32"	36"	40"	44"	48"	52"	57"	62"	67"	72"	82"	92"	102"	112"	122"	132"	142"
42"	152	165	183	200	222	237	255	274	291	336	350	377	398	449	492	564	677	733	778	826
48"	165	183	204	214	244	263	280	303	321	368	390	414	439	492	542	615	738	801	849	902
54"	183	204	218	232	263	282	309	324	348	393	426	449	478	538	596	670	796	862	915	974
60"	198	214	232	253	280	309	330	350	379	427	455	488	517	583	642	728	853	928	988	1047
66"	213	229	253	272	306	330	350	384	402	457	489	522	557	625	690	777	911	990	1057	1118
72"	226	247	267	289	322	349	379	402	434	489	527	560	596	670	738	836	974	1057	1125	1197
78"	237	263	282	309	345	373	401	434	463	522	560	596	630	713	789	887	1031	1117	1197	1271
84"	254	276	303	324	363	393	428	457	491	555	594	630	670	759	838	940	1092	1187	1267	1344
90"	267	291	316	343	386	423	452	488	519	583	625	667	710	801	883	994	1149	1250	1336	1422
96"	280	309	335	362	402	441	478	510	544	615	660	706	748	844	936	1049	1210	1313	1401	1500
102"	293	322	349	379	427	463	500	538	575	645	694	738	785	891	987	1101	1268	1377	1478	1569
108"	310	336	364	398	443	488	527	565	602	676	728	775	825	936	1040	1156	1330	1443	1544	1643
114"	322	350	386	414	464	504	554	594	630	710	761	815	867	980	1079	1214	1386	1507	1612	1718
120"	335	364	400	434	488	529	572	617	662	738	794	847	903	1024	1131	1272	1448	1571	1680	1789
126"	348	386	421	452	504	555	599	643	690	771	827	883	942	1067	1180	1321	1505	1635	1751	1867
Premium Finish Surcharge	26		33			44			55			70			96			125		
Cotton Twill/Vinyl Tapes Surcharge	26		33			44			55			70			96			125		

Colors

See Page 12

1½" Cotton Twill Tapes

110 White	162 Mustard	584 Forest Green
138 Taupe	301 Harvest	662 Midnight Blue
140 Eggshell	503 Celadon	890 Black

1½" Vinyl Tapes

110 White	310 Sand
140 Eggshell	820 Squirrel Gray

Basic Finishes

Solid

Base Pricing

Premium Slat Finishes

Metallic

See Pricing Chart Above for Surcharge
See Page 12 for Color Chart

Free Options*

2" Slat Framed Valance for Retail Orders (Surcharge applies for contract quotes)

Hold-down Brackets

Control Options:

- Tilter Left, Lift Cord Right (Standard)
- Tilter Right, Lift Cord Left
- All Controls Left
- All Controls Right

(See page 37 for specifications, including size limitations)

Extension Brackets (Choose from 2" or 4")

* Must be requested at time of order.

Surcharge Options

Add to the Price of the Blind:

Blinds 17" in width or less	\$37
Multi-Color Striping: Each Color (max 6 total)	\$40
Multiple Blinds on One Headrail: 2 Blinds per Headrail	\$90
3 Blinds per Headrail	\$125
Cutout Option: Side Cutout	\$50 per side
Center Cutout	\$70
Additional or Separate Valance	\$75
Cotton Twill/Vinyl Tapes	See Pricing Chart and Color Chart Above

Riviera® ½" Blind

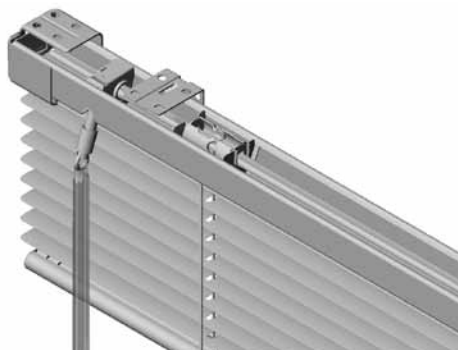

Features

- DustGuard®
- Steel Internal Headrail Components
- Headrail: 1" High x 1 5/8" Wide
- ½" Slat Width
- 8 Gauge Slat
- Guardian Tilter Disengaging Clutch Mechanism
- Crash Proof Cordlock
- Double Slat Vogue Valance Available
- Limited Lifetime Warranty
- 11.75mm Ladder Spacing

Riviera ½"

(RIV12)

Height to	Width to																			
	23"	26"	29"	32"	36"	40"	44"	48"	52"	57"	62"	67"	72"	82"	92"	102"	112"	122"	132"	142"
42"	161	177	192	209	247	265	287	303	327	364	387	411	443	496	542	612	728	797	851	903
48"	177	192	211	228	269	292	310	337	354	402	428	452	482	541	596	674	798	863	921	979
54"	192	211	229	247	292	316	337	358	383	434	460	496	520	595	646	736	861	932	998	1058
60"	210	228	247	260	310	337	364	387	411	464	501	537	565	642	705	791	928	1006	1072	1143
66"	229	247	265	289	333	358	387	414	446	502	540	572	607	689	758	853	993	1072	1154	1221
72"	242	260	287	305	354	385	414	446	476	540	572	610	652	736	815	909	1057	1153	1225	1304
78"	255	278	301	323	377	410	445	476	507	567	610	652	693	784	864	967	1121	1217	1299	1379
84"	265	292	317	341	402	434	470	502	540	603	646	691	736	831	912	1031	1183	1275	1369	1455
90"	279	307	339	358	423	457	497	537	567	642	688	735	780	881	967	1093	1250	1328	1427	1514
96"	293	323	352	380	446	484	520	564	600	671	722	771	818	931	1027	1154	1304	1392	1492	1590
102"	310	340	368	397	464	507	550	595	631	708	759	815	864	975	1079	1206	1364	1456	1556	1657
108"	323	352	383	414	488	537	575	623	662	743	796	852	904	1024	1132	1255	1431	1514	1623	1731
114"	333	368	397	433	501	551	599	649	691	771	831	887	944	1064	1181	1310	1490	1590	1707	1821
120"	350	383	411	449	520	572	623	674	719	799	857	929	984	1110	1230	1364	1549	1652	1776	1892
126"	356	397	429	464	541	596	645	697	744	832	894	960	1020	1153	1271	1420	1603	1715	1845	1964
Premium Finish Surcharge	30		37		48			59			74			103			137			

Colors

See Page 12

Basic Finishes

Solid

Base Pricing

Premium Slat Finishes

Metallic

See Pricing Chart Above for Surcharge
See Page 12 for Color Chart

Free Options*

2 Slat Framed Vogue Valance for Retail Orders (Surcharge applies for contract quotes)

Hold-down Brackets

Control Options:

- Tilter Left, Lift Cord Right (Standard)
- Tilter Right, Lift Cord Left
- All Controls Left
- All Controls Right

(See page 37 for specifications, including size limitations)

Extension Brackets (Choose from 1 ¼" or 2 ¾" to 4 ¼")

* Must be requested at time of order.

Surcharge Options

Add to the Price of the Blind:

Blinds 17" in width or less \$37

Multi-Color Striping:
Each Color (max 6 total) \$40

Multiple Blinds on One Headrail:
2 Blinds per Headrail \$90
3 Blinds per Headrail \$125

Cutout Option:
Side Cutout \$50 per side
Center Cutout \$70

Additional or Separate Vogue Valance \$75

Monaco® 6 1" Blind

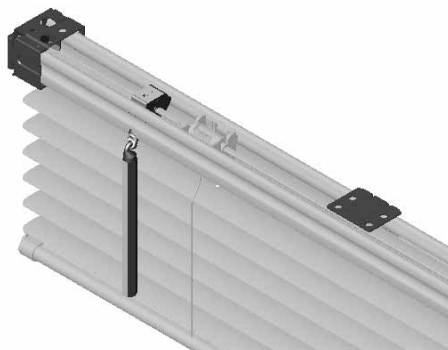

Features

- DustGuard®
- Headrail: 1⁵/₁₆" High x 1³/₈" Wide
- 1" Slat Width
- 6 Gauge Slat
- Available LightMaster™
- Limited Lifetime Warranty
- Maximum Size Available 96" x 96"
- 21.5mm Ladder Spacing (Standard)
- 18mm Ladder Spacing (LightMaster™)
- Color-Coordinated Box Brackets Standard (Hidden Brackets Available)

Monaco 6® 1" LightMaster™

(MON6P)

	Width to															
	23"	26"	29"	32"	36"	40"	44"	48"	52"	57"	62"	67"	72"	82"	92"	96"
Height to 42"	118	132	146	161	175	189	203	217	231	274	288	307	331	368	411	458
48"	132	146	161	170	194	208	227	241	255	302	317	340	354	411	449	505
54"	146	161	175	184	208	227	246	260	274	321	345	368	387	444	487	548
60"	161	170	184	203	227	246	265	279	298	350	373	402	425	482	529	595
66"	170	184	198	217	241	260	279	307	321	373	402	430	458	515	572	638
72"	179	194	208	231	255	279	307	321	345	402	430	458	487	543	609	685
78"	189	208	227	246	274	298	321	345	368	425	458	487	520	586	647	732
84"	203	217	241	255	293	312	340	364	392	453	487	515	548	624	690	775
90"	208	231	255	274	307	331	359	392	411	482	515	543	586	661	723	817
96"	227	250	269	288	321	350	378	406	439	505	538	576	614	694	770	864
Premium Finish Surcharge	19		24				28			38			52			

Monaco 6® 1"

(MON6)

	Width to															
	23"	26"	29"	32"	36"	40"	44"	48"	52"	57"	62"	67"	72"	82"	92"	96"
Height to 42"	112	125	134	148	163	176	190	203	215	247	259	277	299	336	369	415
48"	125	134	149	159	181	193	212	225	237	272	287	306	322	369	403	456
54"	134	149	162	172	193	212	228	240	256	293	310	333	350	401	439	496
60"	148	159	172	187	212	228	247	259	277	316	340	365	381	436	478	534
66"	156	169	186	198	225	240	259	284	301	340	366	385	412	467	513	576
72"	166	183	194	214	239	258	284	301	321	366	385	413	440	495	551	622
78"	176	193	213	228	255	276	300	320	342	383	413	440	470	529	585	659
84"	187	203	225	239	272	293	318	340	366	411	439	468	496	561	624	696
90"	194	215	236	255	285	308	336	365	383	437	467	495	527	595	656	739
96"	210	229	251	269	301	327	350	379	410	455	488	520	557	627	692	782
Premium Finish Surcharge	14		19				25			33			47			

Monaco 6® 1" Blind Options

Colors

See Page 12

Basic Finishes

Solid Base Pricing

Premium Slat Finishes

Metallic See Pricing Chart Page 23 for Surcharge
See Page 12 for Color Chart

Free Options*

Hold-down Brackets

Control Options:

- Tilter Left, Lift Cord Right (Standard)
- Tilter Right, Lift Cord Left
- All Controls Left
- All Controls Right

(See page 37 for specifications, including size limitations)

Extension Brackets (Choose from 1¼" or 2¾" to 4¼")

Side Mount Brackets (Limited to 48"W x 80"H maximum blind size)

Surcharge Options













Add to the Price of the Blind:

Blinds 17" in width or less	\$47
Additional or Separate Vogue Valance	\$75
Hidden Brackets	\$10

* Must be requested at time of order.

Riviera® Specialty Metal Blinds

Features and Functions

													
	Incline	Skylight	Arch	Half-Arch	A-Frame/ Inverted A-Frame	Double Taper, Top Wider	Circle, Oval	Polygon	Triangle	Taper, Bottom Wider	Taper, Top Wider	Double Taper, Bottom Wider	Top Down/ Bottom Up
Blind has full lift capability	■					■					■		■
Blind will not lift		■											
Lifts to bottom of headrail			■	■	■		■	■	■	■		■	
Lifts to top of bottomrail				■	■								
Lifts partially if mounted OM					■			■		■			
Blind has full tilt capability	■		■	■	■	■	■	■	■	■	■	■	■
Tilts 120° to 140°		■											
Headrail is curved			■	■			■						
Slats may fan at low or high peaks				■	■								
Ladders may not be evenly spaced			■	■	■		■	■	■	■	■	■	
Ladders usually end at last slat						■	■	■		■			
Vogue® valance standard	■				■	■	■	■	■	■	■	■	■
Template required			■	■			■	■					
Split controls recommended			■		■	■	■	■			■	■	
Both controls on same side				■						■			
Applications from vertical to 45°	■												
Applications from 45° to horizontal		■											
Wand tilt standard	■	■	■	■	■	■	■	■	■	■	■	■	■
Universal tilt and pole available	■	■	■	■	■	■	■	■	■	■	■	■	■
Smooth one-piece Riviera® headrail	■	■	■	■	■	■	■	●	●	●	■	●	■
No further assembly necessary	■	■	■	■	■	■	■	■	■	■	■	■	■

● Headrail Jointed

Surcharge Options

Add to the Price of the Blind:

Universal Tilt Adapter	\$20
Adjuster (Left or Right)	\$20
Top-Lok Cord Lock	\$5
Restrictive Tilter	\$5
Jointed Wands (price per wand section)	\$5
Cord Cleats	\$5
Wand Holders	\$10
Skylight Pole, 4'	\$45
Skylight Pole, 6'-10'	\$60
Skylight Pole, 8'-16'	\$100
Multi-color Striping:	
Each Color (max 6 total)	\$40

Basic Finishes

Solid
Tiltone

Base Pricing

Premium Slat Finishes

Pearlescence
Opulescence
Metallic
Native Stone
SheerView

See Specific Specialty
Pricing Charts Pages 26-31

Riviera® Specialty Metal Blinds: Incline and Skylight

Specialty Shapes: Incline

(RIV-S)

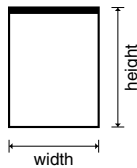
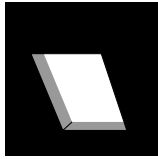

Incline with Top Headrail

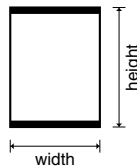

Incline with Top and Bottom Headrail

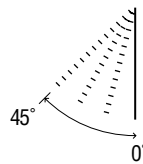

Applications

Height to	Width to															
	23"	26"	29"	32"	36"	40"	44"	48"	52"	57"	62"	67"	72"	82"	92"	102"
42"	224	237	245	303	320	334	350	365	379	412	470	492	507	613	646	739
48"	237	245	260	315	339	354	369	385	402	438	502	523	544	646	688	783
54"	245	260	274	332	354	370	392	405	424	462	530	551	575	686	729	828
60"	259	272	286	345	369	392	411	428	449	489	554	580	603	722	772	875
66"	271	284	305	362	391	411	428	455	470	511	581	609	641	753	812	915
72"	281	300	313	373	403	427	449	470	495	541	615	642	669	793	848	963
78"	290	310	330	392	420	446	469	495	520	566	642	669	700	830	890	1006
84"	306	321	342	405	438	462	492	511	542	594	667	700	734	866	931	1051
90"	313	335	355	417	456	484	508	538	565	618	693	729	767	902	971	1095
96"	324	349	370	435	470	502	531	557	588	644	723	762	797	938	1010	1142
102"	337	361	382	449	489	520	550	580	613	669	752	789	830	974	1055	1183
108"	350	372	397	464	505	538	571	602	637	691	779	818	861	1010	1095	1230
114"	361	383	412	479	521	555	593	625	656	722	811	852	896	1050	1131	1277
120"	370	397	424	495	538	575	609	638	684	748	836	879	926	1085	1173	1322
126"	381	412	440	508	555	594	630	667	706	773	863	909	960	1120	1214	1365
Bottom Headrail Surcharge	56															
Premium Finish Surcharge	35				48				63				90			
SheerView Surcharge	120				167				219				314			

Specialty Shapes: Skylight

(RIV-S)

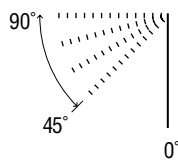
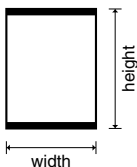
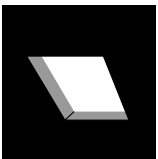

Applications

Height to	Width to															
	23"	26"	29"	32"	36"	40"	44"	48"	52"	57"	62"	67"	72"	82"	92"	
42"	311	321	333	370	391	402	417	433	446	480	523	544	562	655	689	
48"	321	333	349	383	410	423	438	456	470	506	553	573	594	689	729	
54"	366	382	397	441	464	482	504	520	537	573	635	655	678	788	836	
60"	381	394	405	459	480	504	523	541	564	601	657	686	709	827	875	
66"	392	404	424	476	502	523	541	566	581	625	687	713	743	860	911	
72"	402	417	434	485	517	538	564	581	607	653	719	746	774	897	954	
78"	445	464	482	554	583	612	632	657	684	728	814	842	873	1021	1082	
84"	460	478	498	570	601	625	655	677	705	757	841	873	906	1056	1120	
90"	469	489	508	581	618	648	675	702	726	783	866	903	938	1092	1158	
96"	480	504	526	600	635	665	697	722	750	811	897	933	968	1126	1203	
Premium Finish Surcharge	42				53				59				87			
SheerView Surcharge	147				182				206				308			

Riviera® Specialty Metal Blinds: A-Frame or Double Taper, Top Wider

Specialty Shapes: A-Frame or Double Taper, Top Wider

(RIV-S)

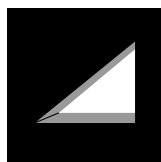

Template
Required

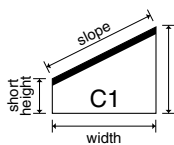

Extended
A-Frame

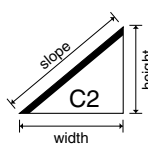

A-Frame

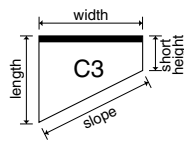

Extended
Inverted
A-Frame

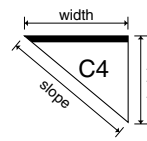

Inverted
A-Frame

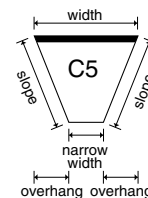

Double
Taper Top
Wider

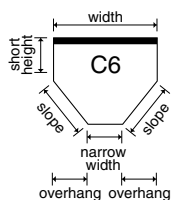

Extended
Double
Taper Top
Wider

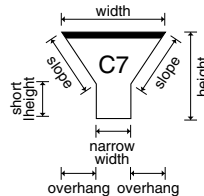

Bottom
Extended
Double Taper
Top Wider

	Width to																			
	23"	26"	29"	32"	36"	40"	44"	48"	52"	57"	62"	67"	72"	82"	92"	102"	112"	122"	132"	142"
Height to 42"	448	460	469	527	548	560	615	629	684	717	762	783	839	966	1040	1140	1261	1340	1408	1477
48"	460	469	485	544	566	580	635	653	706	743	794	815	875	1003	1083	1181	1309	1392	1466	1536
54"	469	485	500	555	580	596	656	674	728	768	820	843	907	1038	1124	1227	1360	1443	1519	1598
60"	484	497	508	572	595	618	676	691	753	794	845	873	937	1078	1167	1274	1408	1500	1580	1660
66"	495	507	526	589	617	637	691	719	774	817	876	902	971	1111	1205	1316	1455	1552	1638	1720
72"	504	523	537	600	630	653	716	736	798	843	907	932	1001	1149	1245	1363	1505	1605	1692	1782
78"	510	532	550	618	646	674	735	761	820	868	932	963	1030	1184	1284	1407	1553	1657	1751	1844
84"	527	547	566	633	663	688	755	779	844	900	962	991	1062	1222	1326	1451	1602	1714	1807	1906
90"	537	557	578	645	684	711	776	803	867	925	988	1025	1095	1259	1365	1493	1651	1763	1868	1968
96"	549	571	594	662	697	728	798	821	890	949	1017	1054	1126	1296	1407	1539	1701	1819	1919	2030
102"	562	583	607	676	717	747	815	845	915	974	1046	1082	1158	1331	1452	1582	1748	1870	1983	2090
108"	572	595	621	691	732	767	838	868	940	996	1072	1111	1190	1368	1490	1628	1800	1924	2039	2153
114"	583	609	635	706	748	783	860	890	962	1027	1099	1147	1227	1405	1527	1676	1848	1978	2093	2212
120"	594	621	646	721	767	803	875	903	988	1052	1125	1172	1254	1439	1567	1720	1897	2029	2151	2271
126"	603	635	662	736	783	819	897	933	1010	1077	1153	1203	1292	1476	1610	1764	1945	2143	2209	2334
Premium Finish Surcharge	57		72				93				126				176					
SheerView Surcharge	198		254				324				443				615					

Riviera® Specialty Metal Blinds: Arch or Half-Arch

Specialty Shapes: Arch or Half-Arch

(RIV-S)

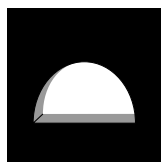

✂️ Template Required
(if not a perfect arch)

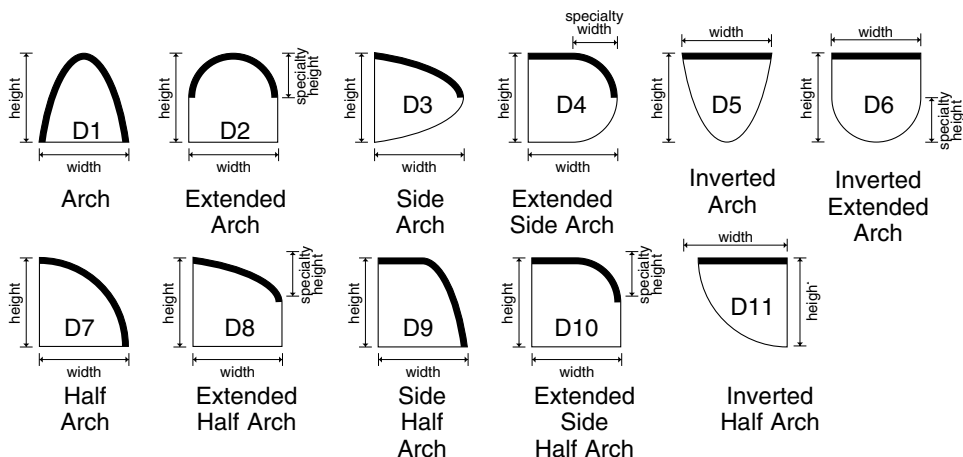

	Width to																			
	23"	26"	29"	32"	36"	40"	44"	48"	52"	57"	62"	67"	72"	82"	92"	102"	112"	122"	132"	142"
Height to 42"	684	691	702	828	845	860	962	974	1126	1160	1279	1301	1394	1551	1681	1834	2029	2205	2379	2529
48"	691	702	719	841	865	879	981	998	1151	1187	1313	1331	1430	1584	1721	1874	2079	2258	2440	2590
54"	702	719	734	853	879	897	1003	1021	1235	1272	1402	1423	1524	1684	1834	1998	2211	2378	2547	2700
60"	717	728	743	873	896	915	1023	1036	1260	1300	1427	1453	1553	1721	1872	2046	2263	2434	2608	2762
66"	726	742	761	886	914	937	1036	1065	1279	1325	1454	1478	1588	1756	1913	2090	2306	2485	2666	2821
72"	737	753	772	900	929	950	1059	1083	1304	1348	1487	1513	1619	1793	1955	2136	2356	2541	2721	2882
78"	748	768	784	915	944	972	1082	1108	1328	1376	1513	1539	1649	1829	1994	2178	2406	2590	2778	2945
84"	762	779	799	932	963	988	1104	1124	1351	1405	1538	1571	1681	1868	2032	2221	2457	2648	2835	3005
90"	772	790	813	943	981	1008	1121	1149	1372	1429	1565	1601	1714	1899	2075	2268	2505	2699	2896	3070
96"	783	805	828	962	996	1027	1146	1171	1394	1455	1595	1633	1744	1936	2115	2314	2554	2751	2947	3132
102"	796	816	839	974	1014	1046	1160	1192	1423	1482	1624	1659	1777	1973	2157	2355	2601	2805	3011	3189
108"	807	830	852	991	1030	1062	1183	1215	1445	1503	1650	1689	1807	2012	2201	2399	2652	2857	3067	3255
114"	816	841	868	1005	1048	1083	1205	1238	1467	1532	1679	1724	1843	2048	2237	2449	2701	2909	3122	3314
120"	828	852	881	1022	1062	1099	1218	1250	1491	1555	1703	1748	1871	2083	2275	2494	2751	2963	3179	3372
126"	838	868	897	1034	1083	1120	1242	1279	1516	1582	1733	1780	1907	2118	2317	2537	2797	3077	3236	3437
Premium Finish Surcharge	81			105				146					194				273			
SheerView Surcharge	287			366				510					680				956			

Riviera® Specialty Metal Blinds: Circle, Oval or Polygon

Specialty Shapes: Circle, Oval or Polygon

(RIV-S)

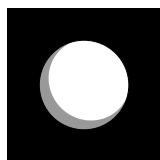

✂️ Template Required

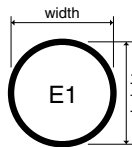

Circle

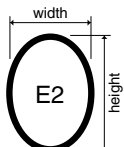

Oval

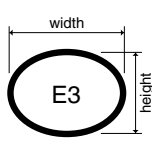

Oval

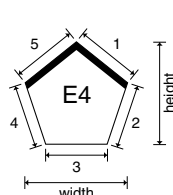

Pentagon
(5 Sides)

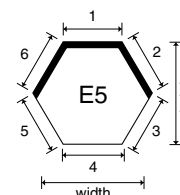

Hexagon
(6 Sides)

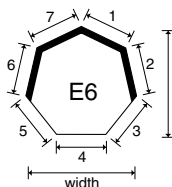

Heptagon
(7 Sides)

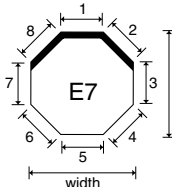

Octagon
(8 Sides)

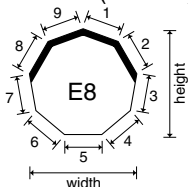

9 Sided
Polygon

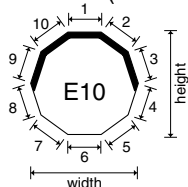

10 Sided
Polygon

	Width to															
	23"	26"	29"	32"	36"	40"	44"	48"	52"	57"	62"	67"	72"	82"	92"	102"
Height to 42"	838	847	859	984	1001	1013	1143	1156	1300	1334	1488	1509	1672	1896	2113	2171
48"	847	859	875	996	1022	1033	1160	1180	1325	1361	1518	1538	1707	1932	2153	2212
54"	859	875	886	1008	1033	1052	1183	1199	1345	1384	1549	1567	1740	1967	2196	2258
60"	873	883	899	1027	1051	1072	1204	1218	1370	1411	1572	1598	1770	2006	2237	2304
66"	882	897	914	1044	1070	1092	1218	1246	1392	1436	1600	1625	1803	2038	2274	2349
72"	895	909	927	1055	1085	1108	1242	1264	1416	1461	1633	1658	1834	2078	2315	2394
78"	902	925	939	1072	1099	1126	1261	1290	1440	1488	1658	1686	1864	2114	2355	2438
84"	915	933	957	1087	1119	1143	1282	1306	1462	1516	1685	1716	1896	2150	2396	2481
90"	927	944	966	1098	1136	1167	1302	1330	1487	1539	1712	1747	1931	2185	2436	2526
96"	938	961	984	1118	1151	1182	1326	1351	1509	1566	1741	1778	1959	2221	2478	2573
102"	949	972	995	1130	1171	1199	1342	1372	1534	1592	1771	1806	1993	2261	2519	2613
108"	962	986	1007	1147	1184	1217	1365	1394	1558	1614	1797	1835	2022	2295	2560	2660
114"	972	996	1025	1158	1203	1238	1388	1419	1579	1645	1825	1870	2057	2331	2597	2708
120"	984	1007	1034	1174	1217	1256	1402	1430	1603	1670	1850	1896	2088	2368	2639	2753
126"	993	1025	1052	1190	1238	1276	1424	1461	1628	1695	1876	1930	2121	2402	2679	2796
Premium Finish Surcharge	98		122				159				224					
SheerView Surcharge	341		425				558				782					

Riviera® Specialty Metal Blinds: Triangle or Taper, Bottom Wider & Taper, Top Wider

Specialty Shapes: Triangle or Taper, Bottom Wider (RIV-S)



Template Required

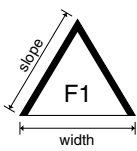

Triangle

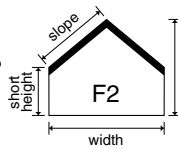

Extended Triangle

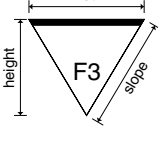

Inverted Triangle

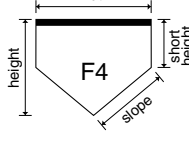

Inverted Extended Triangle

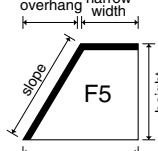

Taper Bottom Wider

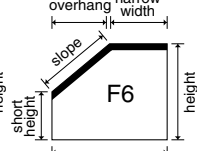

Extended Taper Bottom Wider

Height to	Width to																			
	23"	26"	29"	32"	36"	40"	44"	48"	52"	57"	62"	67"	72"	82"	92"	102"	112"	122"	132"	142"
42"	641	652	657	734	751	765	815	830	868	903	962	984	1026	1104	1172	1293	1427	1507	1597	1668
48"	652	657	676	748	772	784	836	851	895	929	993	1013	1058	1139	1214	1334	1474	1560	1655	1728
54"	676	691	706	777	801	818	875	889	932	971	1036	1058	1110	1192	1274	1394	1538	1628	1726	1806
60"	717	728	743	819	842	865	918	937	986	1025	1088	1117	1167	1256	1340	1468	1615	1710	1810	1895
66"	726	742	761	837	864	883	937	962	1005	1050	1118	1143	1199	1292	1379	1513	1662	1762	1869	1956
72"	753	773	788	865	896	915	974	996	1048	1092	1168	1192	1247	1343	1436	1576	1728	1835	1939	2033
78"	765	784	801	882	910	938	995	1022	1070	1118	1192	1219	1277	1381	1477	1619	1777	1885	1998	2094
84"	805	820	842	926	957	979	1044	1065	1119	1172	1246	1277	1338	1443	1541	1686	1851	1967	2082	2181
90"	814	836	853	937	972	1001	1059	1088	1142	1196	1272	1307	1368	1478	1582	1734	1901	2017	2141	2244
96"	851	875	897	979	1013	1046	1110	1136	1189	1247	1327	1365	1427	1539	1650	1805	1978	2094	2219	2333
102"	864	884	908	993	1032	1059	1126	1157	1215	1274	1359	1392	1457	1579	1692	1846	2023	2150	2281	2393
108"	876	899	925	1007	1050	1082	1149	1181	1239	1297	1383	1423	1489	1614	1734	1893	2078	2204	2337	2457
114"	884	909	938	1023	1062	1098	1171	1204	1260	1326	1411	1456	1524	1651	1771	1939	2123	2256	2394	2515
120"	897	925	949	1035	1082	1119	1184	1215	1284	1348	1437	1483	1553	1686	1810	1986	2175	2306	2450	2575
126"	907	938	964	1054	1098	1139	1209	1246	1308	1376	1465	1514	1588	1724	1850	2029	2219	2422	2511	2639
Premium Finish Surcharge	84		99				119				149				201					
SheerView Surcharge	291		348				416				521				702					

Specialty Shapes: Taper, Top Wider (RIV-S)



Template Required

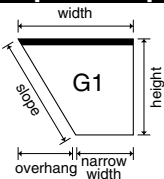

Taper Top Wider

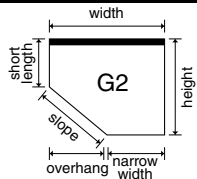

Extended Taper Top Wider

If overhang is less than 8½", price as standard Riviera® 1" with cutout charge.

Height to	Width to																			
	23"	26"	29"	32"	36"	40"	44"	48"	52"	57"	62"	67"	72"	82"	92"	102"	112"	122"	132"	142"
42"	307	317	327	366	385	398	435	449	485	521	551	572	613	704	757	839	952	1016	1070	1124
48"	317	327	342	380	403	416	456	473	508	547	583	603	646	736	799	881	1001	1069	1128	1184
54"	327	342	358	394	416	435	478	494	531	570	613	633	678	774	842	928	1050	1120	1182	1246
60"	340	354	368	412	434	458	497	511	557	596	637	662	709	814	882	973	1097	1177	1244	1308
66"	352	366	385	427	455	476	511	541	578	622	663	690	743	844	925	1017	1146	1229	1300	1368
72"	364	380	397	438	469	489	537	555	601	646	697	722	774	882	962	1062	1193	1280	1357	1431
78"	372	392	411	458	485	509	554	580	625	674	722	752	803	918	1003	1105	1244	1332	1414	1491
84"	386	403	426	473	502	526	578	600	648	704	750	782	837	959	1044	1149	1295	1390	1469	1553
90"	397	415	436	484	521	549	595	624	671	726	777	814	868	991	1083	1196	1341	1440	1530	1616
96"	410	431	454	501	533	566	618	644	693	752	806	843	900	1028	1122	1239	1391	1491	1581	1678
102"	420	441	463	511	554	583	637	666	720	779	836	870	932	1065	1168	1282	1439	1548	1645	1738
108"	433	455	478	530	570	601	657	689	746	801	861	902	963	1100	1209	1327	1489	1600	1701	1802
114"	441	464	495	545	586	622	678	713	767	831	890	933	998	1140	1245	1376	1536	1652	1757	1864
120"	454	478	506	560	601	642	693	723	790	853	915	962	1027	1174	1284	1422	1587	1705	1812	1919
126"	462	495	523	573	622	659	717	753	815	880	942	991	1059	1212	1326	1462	1634	1820	1871	1985
Premium Finish Surcharge	42		56				72				99				143					
SheerView Surcharge	147		194				252				350				500					

Riviera® Specialty Metal Blinds: Double Taper, Bottom Wider & Top Down/Bottom Up

Specialty Shapes: Double Taper, Bottom Wider

(RIV-S)

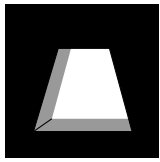

Template Required

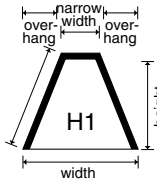

Double Taper Bottom Wider

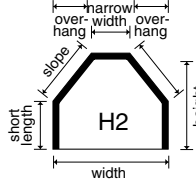

Extended Double Taper Bottom Wider

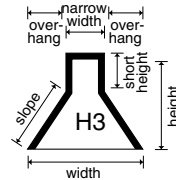

Top Extended Double Taper Bottom Wider

Height to	Width to																			
	23"	26"	29"	32"	36"	40"	44"	48"	52"	57"	62"	67"	72"	82"	92"	102"	112"	122"	132"	142"
42"	995	1005	1014	1130	1149	1160	1238	1251	1308	1343	1431	1454	1514	1615	1709	1870	2029	2136	2261	2355
48"	1005	1014	1030	1146	1170	1182	1256	1274	1334	1369	1462	1485	1549	1651	1750	1913	2079	2187	2318	2417
54"	1044	1059	1076	1187	1212	1230	1307	1325	1386	1423	1523	1541	1611	1717	1824	1987	2154	2268	2399	2507
60"	1104	1117	1128	1248	1272	1296	1370	1389	1455	1492	1590	1615	1684	1801	1907	2078	2248	2368	2506	2611
66"	1115	1126	1147	1264	1293	1313	1389	1413	1476	1518	1619	1644	1718	1833	1945	2121	2296	2419	2563	2673
72"	1153	1171	1184	1306	1336	1360	1439	1460	1529	1573	1680	1705	1778	1898	2016	2198	2372	2505	2644	2764
78"	1160	1182	1199	1323	1351	1378	1458	1485	1553	1600	1705	1734	1807	1935	2056	2239	2422	2554	2705	2827
84"	1219	1238	1260	1383	1413	1437	1525	1549	1620	1672	1777	1807	1887	2017	2140	2327	2515	2655	2807	2928
90"	1230	1250	1272	1393	1430	1460	1544	1572	1643	1696	1803	1840	1917	2052	2180	2373	2564	2705	2865	2993
96"	1284	1307	1330	1456	1490	1520	1611	1635	1709	1766	1874	1914	1993	2132	2266	2461	2658	2801	2962	3099
102"	1298	1321	1342	1469	1509	1536	1628	1658	1734	1793	1906	1939	2027	2171	2306	2506	2705	2855	3024	3158
108"	1308	1331	1359	1485	1524	1557	1651	1681	1758	1812	1932	1970	2056	2206	2350	2549	2755	2907	3082	3224
114"	1321	1343	1370	1499	1539	1578	1671	1703	1778	1844	1961	2004	2091	2242	2387	2598	2805	2962	3136	3282
120"	1330	1359	1384	1514	1557	1595	1685	1716	1805	1869	1987	2030	2118	2276	2426	2642	2855	3015	3194	3340
126"	1341	1370	1399	1531	1578	1614	1709	1746	1829	1894	2015	2061	2154	2315	2465	2687	2900	3126	3253	3405
Premium Finish Surcharge	125			146				170				207				270				
SheerView Surcharge	437			510				593				723				945				

Specialty Shapes: Top Down/Bottom Up

(RIV-S)

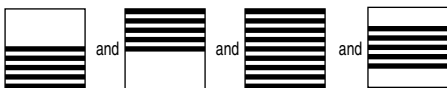
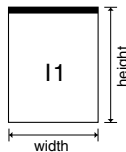
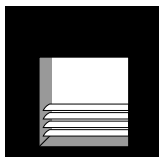

Applications

Height to	Width to										
	23"	26"	29"	32"	36"	40"	44"	48"	52"	57"	62"
42"	332	339	349	387	405	417	435	449	463	498	541
48"	339	349	366	402	427	440	456	473	488	525	570
54"	382	400	414	459	482	501	521	537	553	592	653
60"	398	411	424	477	498	521	541	555	579	618	676
66"	410	423	441	492	520	541	555	581	600	643	704
72"	417	435	454	504	531	554	579	600	624	667	736
78"	462	482	501	571	601	628	652	676	700	748	831
84"	478	495	517	589	618	643	674	693	722	776	860
90"	485	506	527	600	637	665	690	719	746	799	883
96"	498	521	544	617	653	684	714	739	768	827	911
102"	508	532	557	635	666	700	736	761	789	851	942
108"	523	549	573	653	684	717	757	780	813	877	972
114"	532	564	591	667	699	735	780	801	836	903	1001
120"	547	575	603	687	714	751	803	820	859	929	1030
126"	557	591	621	704	728	769	827	842	879	957	1058
Premium Finish Surcharge	16			21				25			
SheerView Surcharge	58			73				87			

Metal Blinds

Features and Options

All Steel Components

High quality, dependable components ensure ease of operation and durability.

Clear, Hex-shaped Wand, S-hook & Sleeve/Star Wand

Easy grip and quality appearance.

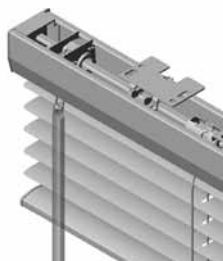

Clear, Snap-on Wand

Resistant to yellowing from sunlight exposure. Snap-on design guarantees easy installation.

Concealed Installation Brackets

Brackets are hidden when blind is installed, providing a clean finished look.

Control Positions

Choice of control positions is available. Tilter left, lift cord right is the standard position. You can choose to reverse the standard position or group the controls on one side.



Tilter Left,
Lift Cord Right



Tilter Right,
Lift Cord Left



Tilter Right,
Lift Cord Right



Tilter Left,
Lift Cord Left

Cordless

Refers to patented technology that allows for easy operation of the blind without using cords to raise and lower; child and pet safe; motor mechanism and cord take up are centered in the headrail and are one piece for dependability.

Crash-Proof Cordlock

Safety feature that holds the blind securely at any level and prevents the blind from crashing to the sill while raising or lowering.

Cutouts

Allows access to air conditioners, window cranks, etc. Center and side cutouts are available. A diagram is required.

DustGuard®

DustGuard is an exclusive paint process that reduces dust build-up on blinds by over 50%. By "disrupting" the static on the blind's aluminum surface, DustGuard actually resists airborne dust particles. DustGuard is totally safe and permanent. Since it is an integral part of the surface, it lasts for the life of the blind.

Enclosed Cushion Bottomrail

A color coordinated vinyl cushion covering the entire width of the blind protects the window sill from scratches and chips.

Extension Brackets (Must be requested at time of order.)

For installations requiring additional space between the blind and the mounting surface. Not available with hold-down brackets.

Guardian Tilter

Provides tighter closure and disengages when over-rotated to safeguard against breakage while providing smooth operation and better quality.

Heavy Duty Headrail

Manufactured of "hardened steel," guaranteed not to rust or corrode.

Hold-down Brackets (Must be requested at time of order.)

Hold-down brackets prevent blinds from swaying. They can be sill mounted, face mounted or mounted inside the frame. Recommended for doors and in windows subject to wind exposure. Not available with extension brackets.

Integrated Valance/Valance Free Design

Sculpted design reduces light leakage and creates a uniform and tailored appearance. Eliminates the need for an additional valance.

LightMaster™

Pull-cord holes are positioned near the back of the slat to provide more light control.

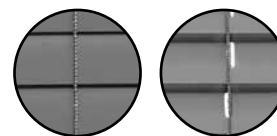

LightMaster™

Standard

Multi-color Striping

Striping allows you to add more color to the room decor as well as match geometric designs on walls. Identify color positions of slats with a sketch. Also, specify the color of components (consider "white" for ladder and cord for uniform appearance).

Multiple Blinds on One Headrail

Specialty blind allowing the customer to operate 2 or 3 independent shades on one headrail. Provides the flexibility of raising one blind while keeping the other lowered on extra wide windows, such as patio doors. Standard spacing is 1/2" between blinds.

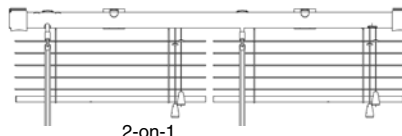

2-on-1

Pivot Plates

Levolor pivot plates are specifically designed to be used with extruded aluminum mullion with pockets. Pivot plates eliminate the need to drill and screw into the aluminum mullion. Shown here is a typical mullion incorporating a slot on either side for the pivot plate. The headrail of the blind is installed into the recessed mullion cavity. Then, the plate is turned into place with a screwdriver. Pivot plates are custom sized based on customer mullion dimensions.

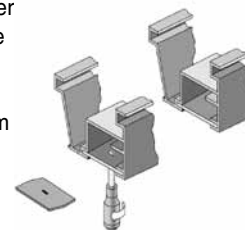

Pivot Plate Detail:

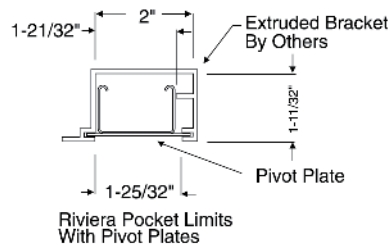

Metal Blinds

Features and Options (continued)

Pocket Brackets

A typical pocket installation may require Levolor pocket brackets. The standard pocket bracket can be installed in two steps: the upper section is first secured in the top of the pocket; then, the flanges on the lower section are snapped over those on the upper section. This secures the headrail in place. The top of the pocket must be sturdy enough to support the weight of the blind and the pull forces applied to it.

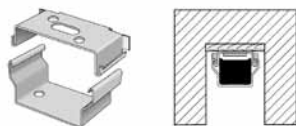

Restrictive Tilter

The Restrictive Tilter limits the range of angles the slat will tilt, ensures adequate window ventilation and reduces heat build-up. Maintains a uniform building exterior when using tiltone colors. See chart at right for available options. Not available with LightMaster™.

SheerView

SheerView provides the ability to see through a closed blind and delivers up to a 42% reduction in solar heat as compared to a fully opened blind. SheerView is available in 5 colors, 6% openness. SheerView cannot be ordered with LightMaster option.

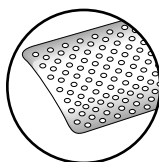

Standard Valance

Standard valances are a simple and economical way to cover the headrail and brackets. Two slats are attached onto the headrail with plastic clips.

Tiltone

Tiltone blinds allow you to bring one color to the interior of your room while providing a uniform, neutral appearance on the exterior of your home. Plus, Tiltone offers additional energy savings. Indicate which side of the slat and ladder is to be covered by marking the appropriate box on the order form. Unless otherwise specified, factory will place neutral white of ladder towards window side of blind and will match color of headrail and bottomrail to decor color on slat.

Top-Lok® Cord Lock/Ring Pull

Top-Lok holds the blind in a completely raised or lowered position, thus ensuring a uniform building exterior. Also, when the blinds are fully raised there is no cord accumulation on the floor. Optional ring pulls are recommended when ordering Top-Lok Cord Lock. Ring pulls hang 3" (±0.5") below the headrail and are an additional charge. Top-Lok is especially useful for installations where the headrail is equal to or greater than eight feet from the floor. Top-Lok also keeps unauthorized personnel from raising or lowering blinds. Authorized personnel may adjust the blinds by hooking an ordinary window pole onto the ring at the end of the lift cord (pole not included).

Vogue® Round Wrap Valance

Innovative valance provides a sleek, finished look for the window. Two slat valance for the Riviera® ½" and 1" blinds and a one slat valance for the Riviera® 2" blinds. The Vogue Round Wrap Valance is available in Riviera 1" models and Riviera 2".

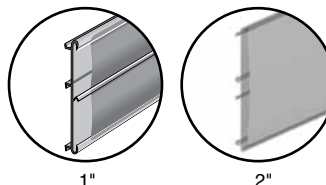

Restrictive tilter options:

option number	performance
6060	60° up 0° 60° down
90111	90° up Level 0°
70111	70° up Level 0°
7575	75° up 0° 75° down
4545	45° up 45° down

Pocket and stacking dimensions

Horizontal Blinds Pocket and Stacking Dimensions

Blind Type	H	B	S	W
Riviera ½"	1.875"	.406"	.625"	3.5"
Riviera Classic 1"	1.875"	.406"	.5"	3.5"
Riviera 2" Braided Ladder	3"	.563"	.375"	4"
Riviera 2" Plastic Tape	3"	.563"	.625"	4"
Monaco® 6 1"	1.875"	.406"	.5"	3.5"
Wood Blind 2"	3"	.625"	1.25"	4"

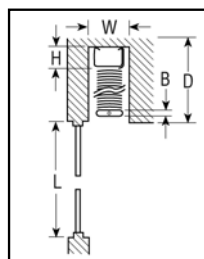

L = Window Height
W = Minimum Pocket Width
H = Headrail Height
(Including Ceiling Gap)
B = Bottomrail Height
S = Slat Stack Height (Per Vertical Foot of Blind)
D = Minimum Pocket Depth
D = H+B+(S x L/12)

Notes: All Dimensions in Inches.
All Heights are Approximate.

Blind Options - Horizontal

	KEY													
	▲ Option	■ Standard	- Not Available	Mark I 1"	Mark I 1 1/2"	Riviera 1" Classic	Riviera Contract	Riviera 1/2"	Riviera 2"	Monaco 6	A-Frame	Arch	Skylight	Incline
Bottom Headrail	-	-	-	-	-	-	-	-	-	-	-	-	■	▲
Butt (Part of Bypass)	▲	▲	▲	▲	▲	▲	▲	▲	▲	▲	▲	-	-	-
Butting Blinds (Touching)	▲	▲	▲	▲	▲	▲	▲	▲	▲	▲	▲	-	-	▲
Bypass (Part of Butt)	▲	▲	▲	▲	▲	▲	▲	▲	▲	▲	▲	-	-	-
Cordless	▲	▲	-	-	-	-	-	-	-	-	-	-	-	-
Cord C90 (Thick)	-	-	-	-	-	-	-	▲	-	-	-	-	-	-
Cord Cleat	▲	▲	▲	▲	▲	▲	▲	▲	▲	▲	▲	▲	-	▲
Cord Tilt	-	-	-	-	-	-	-	▲	-	-	-	-	-	-
Cut-Outs (Traditional Route Holes Only)	▲	▲	▲	▲	▲	▲	▲	▲	-	▲	▲	▲	-	▲
Double Slat Blind	▲	▲	▲	▲	▲	▲	▲	▲	-	▲	▲	▲	▲	▲
End Mount Brackets	▲	▲	■	■	■	■	■	■	■	■	■	■	■	■
Extension Brackets	▲	▲	▲	▲	▲	▲	▲	▲	▲	▲	▲	-	-	▲
Fabric Twill Tapes	-	-	-	-	-	-	-	▲	-	-	-	-	-	-
Guardian Tilter	■	■	■	■	■	■	■	-	-	■	■	■	■	■
Hinged Wand (Link)	▲	▲	▲	▲	▲	▲	▲	▲	-	▲	▲	▲	▲	▲
Hold-Down Brackets	▲	▲	▲	▲	▲	▲	▲	▲	▲	▲	▲	▲	-	▲
Integrated Valance	■	■	-	-	-	-	-	-	■	-	-	-	-	-
LightMaster™	▲	-	▲	-	-	-	-	-	▲	-	-	-	-	-
Multiple Blinds on One Headrail	▲	▲	▲	▲	▲	▲	▲	▲	-	▲	-	-	-	▲
Multi-Color (Striped)	▲	▲	▲	▲	▲	▲	▲	▲	-	▲	▲	▲	▲	▲
Pivot Plate	-	-	▲	▲	▲	▲	▲	-	-	▲	-	-	-	▲
Pocket Bracket	-	-	▲	▲	▲	▲	▲	▲	-	▲	-	▲	▲	▲
Restrictive Tilter	▲	▲	▲	▲	▲	▲	▲	-	-	-	-	-	-	-
Reverse Cord Lock	-	-	▲	▲	▲	▲	▲	-	-	▲	▲	-	-	▲
Ring Pull	▲	▲	▲	▲	▲	▲	▲	▲	-	▲	▲	-	-	▲
SheerView Perforated	▲	-	▲	-	-	-	-	-	-	-	▲	▲	▲	▲
Side-By-Side	▲	▲	▲	▲	▲	▲	▲	▲	▲	▲	▲	▲	▲	▲
Telescopic Pole/Skylight Pole	▲	▲	▲	▲	▲	▲	▲	▲	-	▲	▲	▲	▲	▲
Tilt Wand	■	■	■	■	■	■	■	■	■	■	■	■	■	■
Tiltone Colors	▲	▲	▲	-	-	-	-	-	-	-	▲	▲	▲	▲
Top Lok® Cord Lock	▲	▲	▲	▲	▲	▲	▲	-	-	▲	-	-	-	▲
Universal Ring Tilter	-	-	▲	▲	▲	▲	▲	▲	-	▲	-	■	■	▲
Valance (Non-Vogue) – Contract	-	-	▲	▲	▲	▲	▲	▲	-	▲	-	-	■	▲
Valance Vogue – Contract	-	-	▲	▲	▲	▲	▲	▲	▲	-	-	-	■	▲

Metal Blinds

How to Measure / Minimum Mounting Depth

Inside Mount (IM) Installation

To find width: Measure exact distance to the nearest $\frac{1}{8}$ " between inside surfaces of window frame at the top, middle, and bottom, and use the narrowest width. Do not make any width deductions. Factory will make appropriate deductions.

To find height: Measure exact distance to the nearest $\frac{1}{8}$ " from inside surface at top of window to sill at the left, middle and right and use the longest height. If you prefer blind not to touch sill, deduct $\frac{1}{4}$ ". If there is no sill, measure height to the point where the shade reaches.

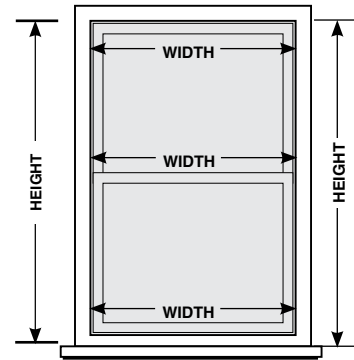

Outside Mount (OM) Installation

To find width: Measure exact distance to the nearest $\frac{1}{8}$ " between the outermost points where the blind is to be placed. For optimal light control, this measurement should extend $\frac{3}{4}$ " beyond the window opening on each side (or $1\frac{1}{2}$ " for the entire width).

To find height: Measure exact distance to the nearest $\frac{1}{8}$ " from where top of the blind will be located to the top of sill. If there is no sill or if blind is to overlap window frame, measure to the point the shade reaches.

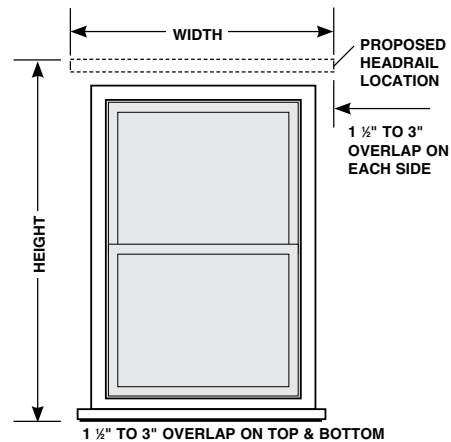

2-on-1 and 3-on-1 Headrail

1. Measure overall width of the area to be covered.
2. Measure width of the area each blind is to cover. Measure and specify the left shade first, continuing to the right. **Factory will allow a minimum of $\frac{1}{2}$ " between shades for operating clearance.**
3. The total width of all shades must equal the total headrail width. If ordering a valance wider than the blind, a diagram is required.
4. To measure height, use standard inside or outside measuring procedures.

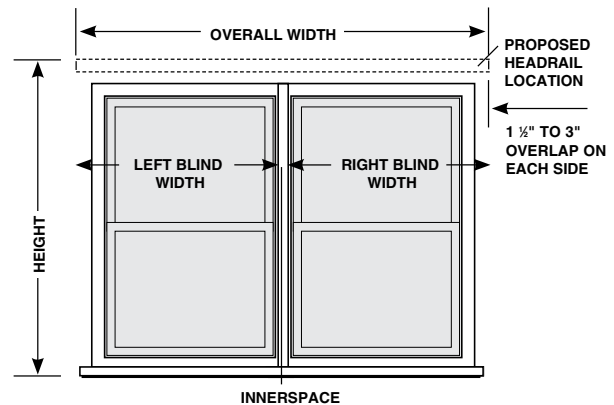

Care Instructions

To keep your Levolor® Metal Blind looking its best, periodically wipe it with a soft dust cloth, a dusting mitt, or a round brush attachment from a vacuum cleaner.

- You can clean the blind hanging in place or you can take it down.
- By tilting the slats down, but not quite closed, you'll be able to clean most of the top surface of each slat.

In a very dusty environment, just clean the blind using a sponge or dampened soft cloth.

- Use warm (not hot) water and mild detergent. The mild detergent cannot contain abrasives.
- Rinse the blind with clean water to prevent water spots.
- Place a towel on the floor or window sill to absorb any water that drips from the blind.

equipment are too harsh and can cause shrinkage and/or color damage to your blind. The Levolor® Lifetime-Limited Warranty does not cover damage caused by cleaning methods that use abrasive solutions or by ultrasonic cleaning machines.

Please note that certain solutions and

Metal Blinds

How to Make a Template

The following instructions show how to make a template if the measuring instructions indicate that one is required for your window shape (Arch, Half-Arch, Circle, Oval, Polygon, or Curve blinds).

You will need the following tools:

- | | |
|-------------------------------|-------------------|
| Craft or Butcher Paper | Masking Tape |
| Pencil and Grease | Measuring Tape |
| Pencil | Carpenter's Level |
| Sharp Knife | Mailing Tube |
| Scissors | |

A Tape the paper to the wall or window frame, stretching tightly to remove all folds and wrinkles. For Arch and Half-Arch blinds, cover the curved portion of the window. For Circle, Oval, or Polygon blinds cover the entire window.

B For Arch and Half-Arch blinds, measure from the sill to the beginning of the curved portion of the blind on both sides. Write each measurement in the lower left and lower right sides of the template respectively.

C Measure from the sill to the top of the window opening and write this measurement on the top of the template.

D Using the carpenter's level, draw a level line from one side of the template to the other (horizontal direction).

E Measure the width of the window in at least two places and write these measurements on the bottom of the template.

F Write your name, mailing address, and telephone number in the middle of the template.

G Draw a sketch of the blind in the center of the template and include dimensions on the sketch.

H Write the words ROOM SIDE in the middle of the template.

I Write the word TOP at the top of the template.

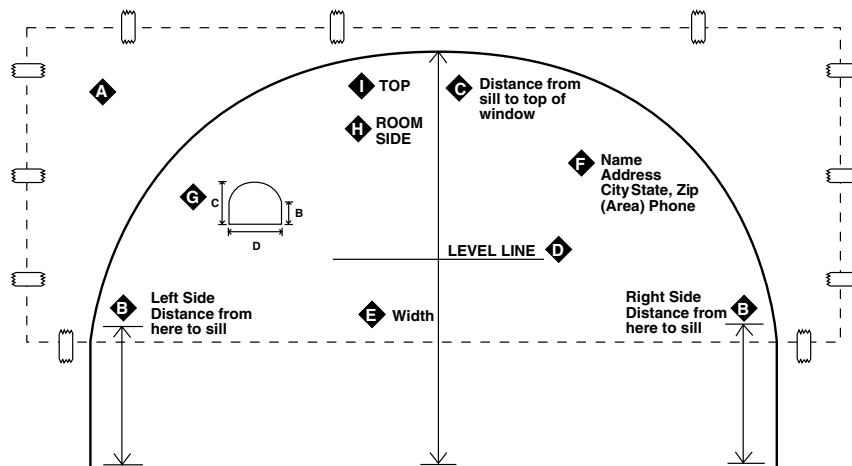

Inside Mount (IM)

For inside mount blind (IM) templates, carefully cut out the template with the sharp knife, leaving an uncut portion every 1 to 2 feet along the cut line. Finally, carefully cut the serrated pieces.

Outside Mount (OM)

For outside mount blind (OM) templates, carefully trace the outline of the window with the grease pencil, then draw in the outline of the blind as it will sit outside of the window outline. Cut the template with scissors along the outside line which the blind is to fit. Hold up the finished template to insure blind fits. Make any template size corrections at this time, or if corrections are not possible, make a new template. Roll the template (DO NOT FOLD) and send it in a mailing tube with the order.

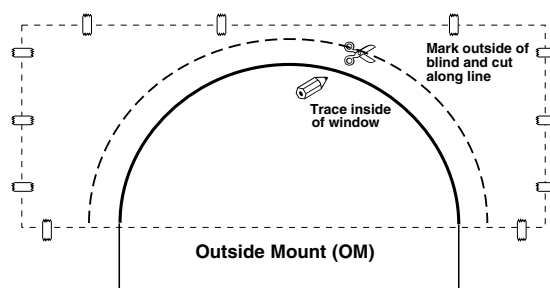
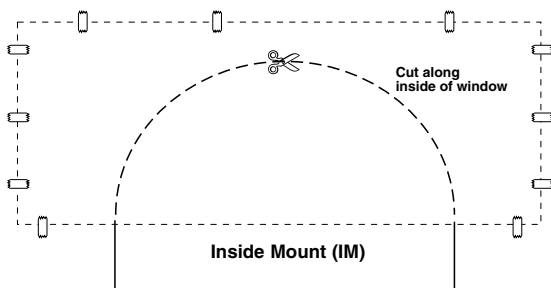

Specifications

NOTE: Blind dimensions must be equal to or less than the maximum dimensions to be within specification guidelines. **Blind dimensions are listed in inches.**

Specifications	Mark I 1 3/8" & Mark I 1"		Riviera® Classic 1"		Riviera® Contract 1"		Riviera® 1/2"		Riviera® 2"		Monaco® 6	
	Inside Mount	Outside Mount	Inside Mount	Outside Mount	Inside Mount	Outside Mount	Inside Mount	Outside Mount	Inside Mount	Outside Mount	Inside Mount	Outside Mount
Minimum Ordered Width												
Cordless	17	16 5/8	N/A		N/A		N/A		N/A		N/A	
Tilt and Lift Same Side	15 3/4	15 1/2	15 1/2	15	14 3/4	14 1/4	18 1/2	18	14 1/2	14		
Tilt and Lift Opposite Sides (Standard)	11	10 1/2	11	10 1/2	11	10 1/2	12 1/2	12	11 1/2	11		
Tilt Control Center; No Lift	7	6 1/2	5	4 1/2	5 1/2	5	6 5/8	6 1/8	8 1/2	8		
No Tilt and Lift Controls; Slats Open	5 3/4	5 1/2	5	4 1/2	5 1/2	5	6 5/8	6 1/8	5 1/2	5		
Minimum Length												
Cordless	6		6		6		6		6		6	
LightMaster™	6		6		N/A		N/A		N/A		6	
Cordless	6		N/A		N/A		N/A		N/A		N/A	
Maximum Ordered Width	Inside Mount	Outside Mount	Inside Mount	Outside Mount	Inside Mount	Outside Mount	Inside Mount	Outside Mount	Inside Mount	Outside Mount	Inside Mount	Outside Mount
2-on-1 and 3-on-1 Headrail	142	142	142	142	142	142	142	142	142	142	N/A	
Cordless	142	142	142	142	142	142	142	142	142	142	96	96
LightMaster™	142	142	142	142			N/A		N/A		96	96
Cordless Single Blind	100 3/8	100	N/A		N/A		N/A		N/A		N/A	
Cordless 2-on-1 Headrail	142	142	N/A		N/A		N/A		N/A		N/A	
Maximum Length												
Cordless	126		126		126		126		126		96	
LightMaster™	126		126		N/A		N/A		N/A		96	
Cordless	73		N/A		N/A		N/A		N/A		N/A	
Standard Factory Deductions												
Inside Mount (IB) Headrail	9/16		3/4		3/4		3/4		3/4		1/2	
Inside Mount (IB) Slat	3/8		1/2		1/2		1/2		1/2		3/8	
Outside Mount (OB) Headrail	3/16		1/4		1/4		1/4		1/4		1/8	
Outside Mount (OB) Slat	0		0		0		0		0		0	
	0		0		0		0		0		0	
Dimensions												
Headrail (Height X Depth)	1 1/2 x 1 5/8		1 x 1 1/16		3/4 x 1 1/16		2 5/16 x 2 1/4		1 5/16 x 1 1/2			
Inside Mount (IB) Bracket (Height X Depth)	7/16 x 1 1/16		1 1/16 x 1 13/16		1 1/8 x 1 1/16		2 5/16 x 2 1/2		1 3/8 x 1 1/16			
Outside Mount (OB) Bracket (Height X Depth)	.35 x 1.125		same as IB		same as IB		same as IB		same as IB			
			.38 x .76		.38 x .76		.545 x 2.08		.38 x .76			
Mounting Requirements												
Inside Mount (IB)	5/8		1/2		1/2		1/2		1/2		5/8	
Minimum Required Mounting Surface	1 3/4		1 13/16		1 1/16		2 1/2		1 3/8			
Minimum Required Depth Flush Mount - No Valance	N/A		2 1/2		1 3/4		3		2 3/16			
Minimum Required Depth Flush Mount - With Valance	1/2		1/2		1/2		3/4		3/8			
Outside Mount (OB)	5/8		1/4		3/16		1/8		1/4			
Minimum Required Mounting Surface	5/16(1")	3/8(1 3/8")	3/8		7/16		1/4		1/2			
Rail-to-mount surface clearance												
Multiple Blinds on One Headrail Spacing												
2-on-1 or 3-on-1 Standard Corded	1/2		1/2		1/2		1/2		N/A		N/A	
2-on-1 or 3-on-1 LightMaster™	1/2		N/A		N/A		N/A		N/A		N/A	
	1/2		N/A		N/A		N/A		N/A		N/A	
Stacking Heights	Inside Mount	Outside Mount										
	1"	1 1/8"										
Stacks To	36 3/4	48 1/4	54		55 3/4		N/A		91			
3"	55	72 1/4	71		71 1/2		21 3/4		N/A			
3.5"	72 1/4	96	88		87 1/4		40 1/4		N/A			
4"	91 1/2	120	105		103		58 3/4		N/A			
4.5"	9 3/4	N/A	122		118 3/4		77 1/4		N/A			
5"	N/A		N/A		N/A		95 3/4		N/A			
5 1/2"	N/A		N/A		N/A		114 1/4		N/A			
Valance Return Lengths												
	N/A		1 7/8		1 7/8		1 7/8		1 7/8		1 7/8	
Standard	N/A		5 1/2		5 1/2		5 1/2		5 1/2		5 1/2	
With Extension Brackets												

N/A = Not Available

Metal Blinds: Mark I 1" and 1 3/8" - Exploded View

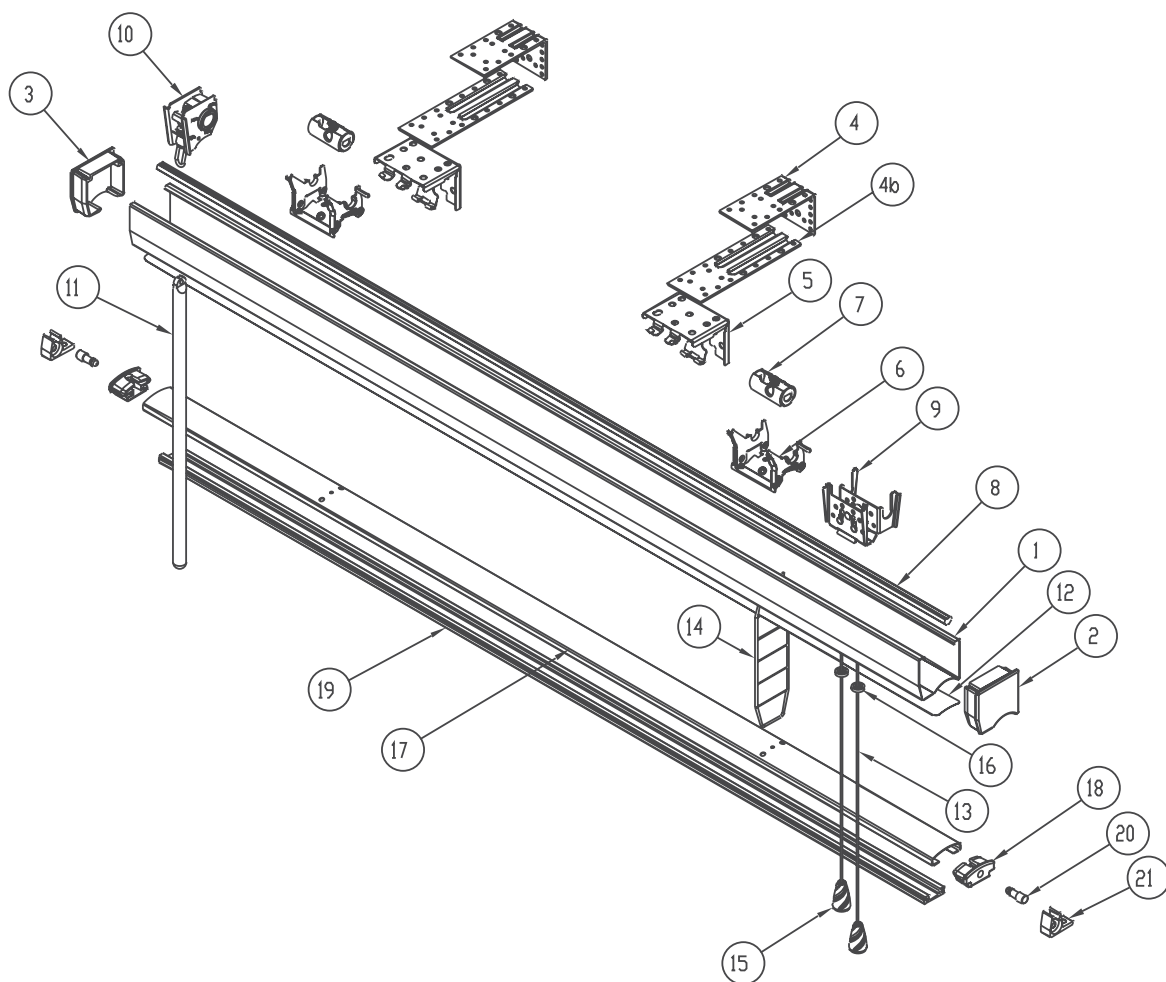

Mark I 1" and 1 3/8"

Item	Part Description	Part Number
1	HEADRAIL	G19M0300
2	HEADRAIL END CAP - RIGHT	G09U5200
3	HEADRAIL END CAP - LEFT	G09U5100
4	EXTENSION BRACKET	HBEX0013
4b	EXTENSION BRACKET PLATE	HBEX0014
5	UNIVERSAL MOUNTING BRACKET	HBCK0096
6	CRADLE	G13C0001
7	DRUM	K13Y0000
8	TILT ROD	E20P0300
9	CORDLOCK ASSEMBLY	G10P0000
10	TILTER ASSEMBLY	G11M0000
11	WAND	G20M0000
12	SLAT	S81D0000
13	CORD	C8800000
14	1" LADDER/1" LADDER OPTION/1" LIGHTMASTER™ LADDER/1 3/8" LADDER	T17Y0000/T17R0000/T18L0000/T18R0000
15	TASSEL	HGTS0001
16	SAFETY CORD STOP	DDW30445
17	BOTTOMRAIL	G19M0300
18	BOTTOMRAIL END CAP	G27M0000
19	BOTTOMRAIL BUMPER	G19M5400
20/21	HOLD-DOWN KIT	G12P9900

Metal Blinds: Riviera Classic 1" & Riviera Contract 1" - Exploded View

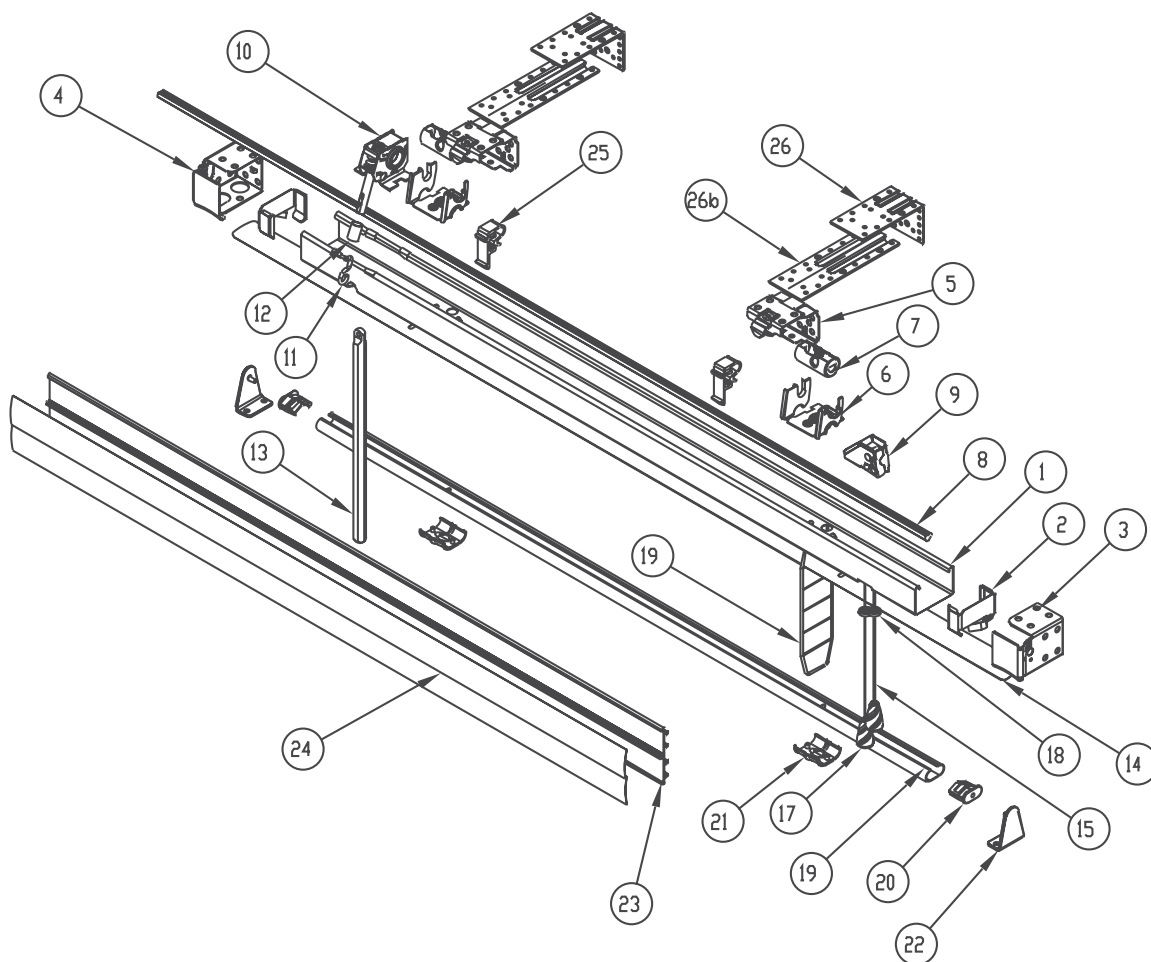

Riviera® Classic 1" & Riviera® Contract 1"

Item	Part Description	Part Number
1	HEADRAIL	K50A0300
2	END BRACE	K09E0400
3	BOX BRACKET - RIGHT	K01E0200
4	BOX BRACKET - LEFT	K01E0200
5	INTERMEDIATE SUPPORT BRACKET	K16F0000
6	CRADLE	K13C0000
7	DRUM	K13Y0000
8	TILT ROD	E20P0300
9	CORDLOCK ASSEMBLY	K10K0000
10	TILTER ASSEMBLY	K11A0000
11	TILTER - S-HOOK	K11B3700
12	TILTER - SLEEVE	K11B2800
13	WAND	K20W0000
14	SLAT	S81D0000
15	CORD	C8800000
16	LADDER/LADDER OPTION/LIGHTMASTER™ LADDER	T17Y0000/T17R0000/TI8L0000
17	TASSEL	HGTS0001
18	SAFETY CORD STOP	DDW30445
19	BOTTOMRAIL	K19B0300
20	BOTTOMRAIL END CAP	DY038310
21	LADDER CAP	K23C0000
22	HOLD-DOWN KIT	DJL01873
23	VALANCE FRAME	K17F5120
24	VALANCE SLAT	S81D0000
25	VALANCE CLIP	U17C0000
26	EXTENSION BRACKET	HBEX0013
26b	EXTENSION BRACKET PLATE	HBEX0014

Metal Blinds: Riviera® 2" - Exploded View

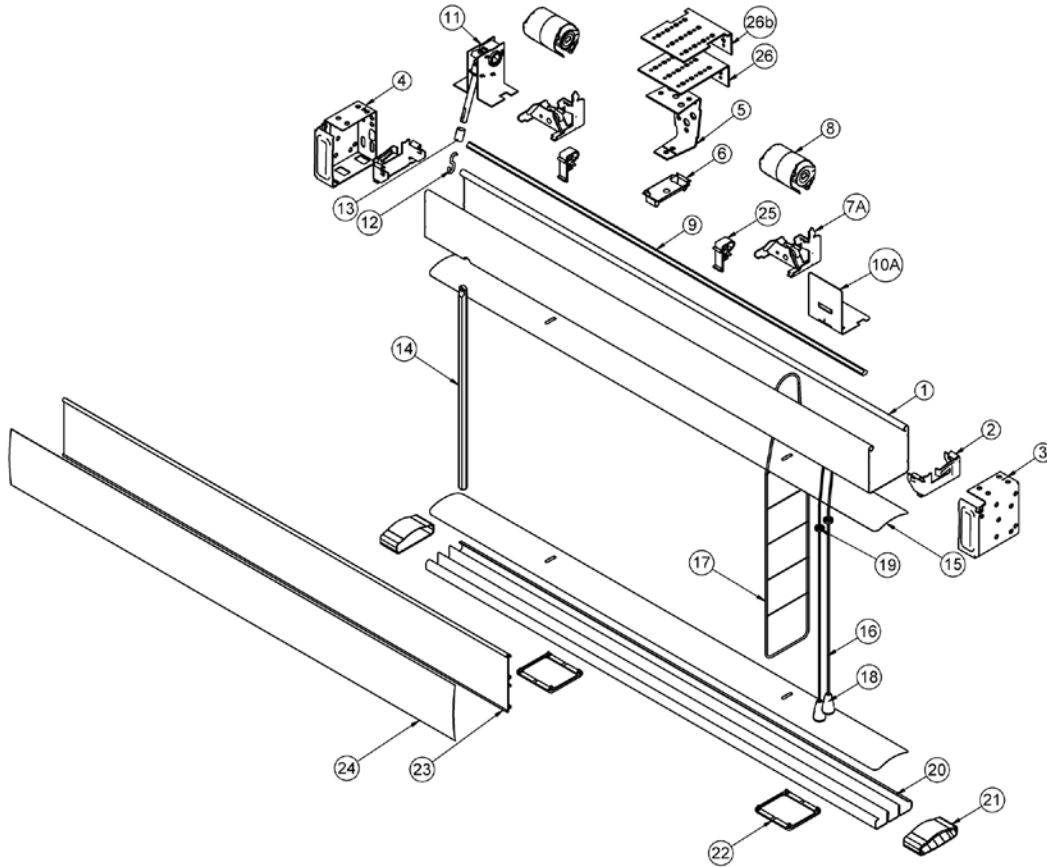

Riviera® 2"

Item	Part Description	Part Number
1	HEADRAIL	E50L0300
2	END BRACE	E09U2000
3	BOX BRACKET - RIGHT	E01A0400
4	BOX BRACKET - LEFT	E01A0400
5	INTERMEDIATE SUPPORT BRACKET	B16A0000
6	TOP BRACE	E09T0000
7A	CRADLE - RIGHT PULLEY	H13T0000
7B	CRADLE - LEFT PULLEY	H13T7000
8	DRUM	H13D0000
9	TILT ROD	E20P0300
10A	CORDLOCK ASSEMBLY - RIGHT	H10S0000
10B	CORDLOCK ASSEMBLY - LEFT	H10S7000
11	TILTER ASSEMBLY	E11W0000
12	TILTER - S-HOOK	K11B3700
13	TILTER - SLEEVE	K11B2800
14	WAND	K20W0000
15	SLAT	S02D0000
16	CORD	C9800000
17	LADDER	T19K0000
18	TASSEL	HGTS0001
19	SAFETY CORD STOP	DDW30445
20	BOTTOMRAIL	E19R0300
21	BOTTOMRAIL END CAP	E29C0000
22	LADDER CAP	H23P0000
23	VALANCE FRAME	K17F7300
24	VALANCE SLAT	S08D0000
25	VALANCE CLIP	U17C0000
26	2" EXTENSION BRACKET	L01X2000
26b	4" EXTENSION BRACKET	L02X4000
NS	HOLD-DOWN KIT (NOT SHOWN)	G12P9900

Metal Blinds: Riviera® 1/2" - Exploded View

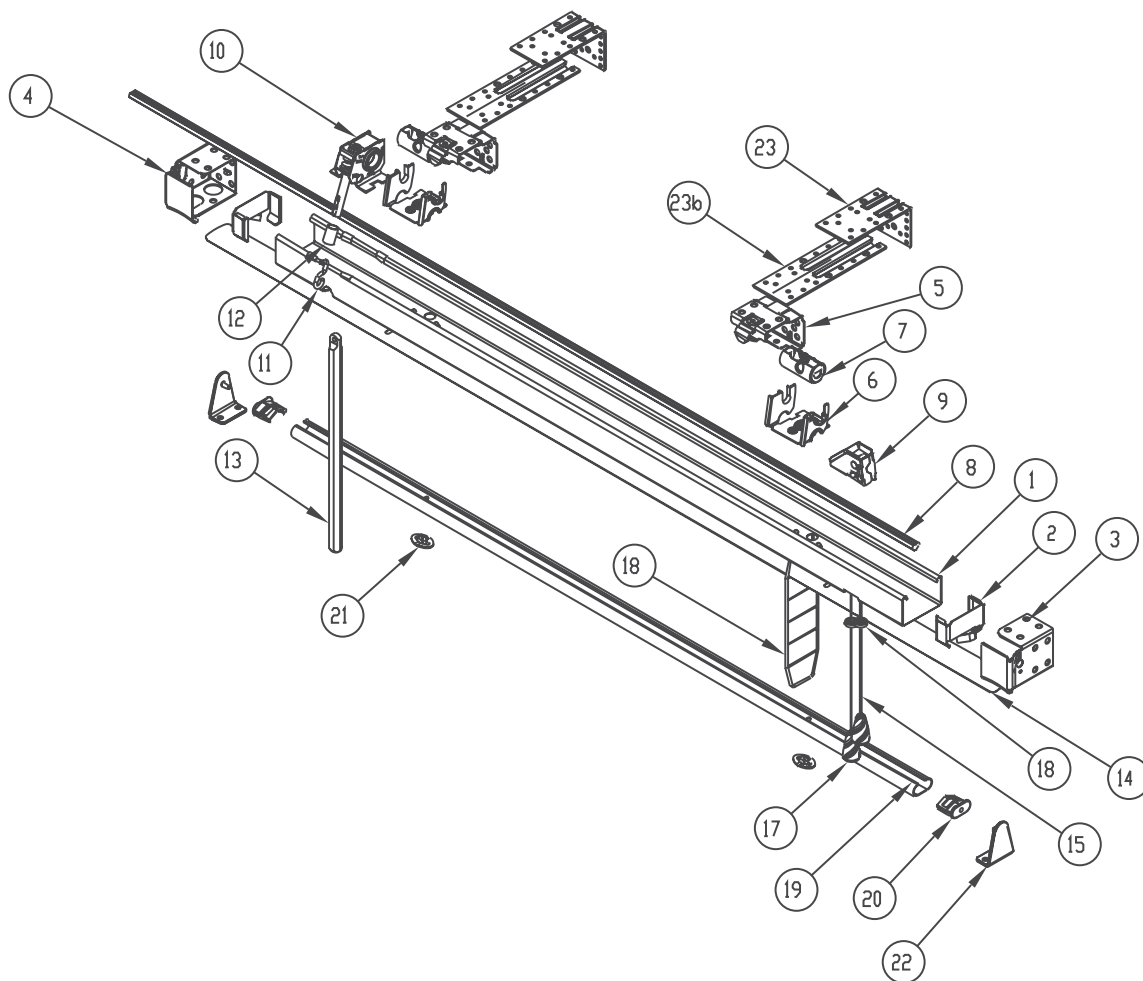

Riviera® 1/2"

Item	Part Description	Part Number
1	HEADRAIL	K50A0300
2	END BRACE	K09E0400
3	BOX BRACKET - RIGHT	K01E0200
4	BOX BRACKET - LEFT	K01E0200
5	INTERMEDIATE SUPPORT BRACKET	K16F0000
6	CRADLE	K13C0000
7	DRUM	K13Y0000
8	TILT ROD	E20P0300
9	CORDLOCK ASSEMBLY	K10K0000
10	TILTER ASSEMBLY	K11A0000
11	TILTER - S-HOOK	K11B3700
12	TILTER - SLEEVE	K11B2800
13	WAND	K20W0000
14	SLAT	S51D0000
15	CORD	C8800000
16	LADDER	T15R0000
17	TASSEL	HGTS0001
18	SAFETY CORD STOP	DDW30445
19	BOTTOMRAIL	K19B0300
20	BOTTOMRAIL END CAP	DY038310
21	LADDER CAP	Y23C0001
22	HOLD-DOWN KIT	DJL01873
23	EXTENSION BRACKET	HBEX0013
23b	EXTENSION BRACKET PLATE	HBEX0014

Metal Blinds: Monaco 6® - Exploded View

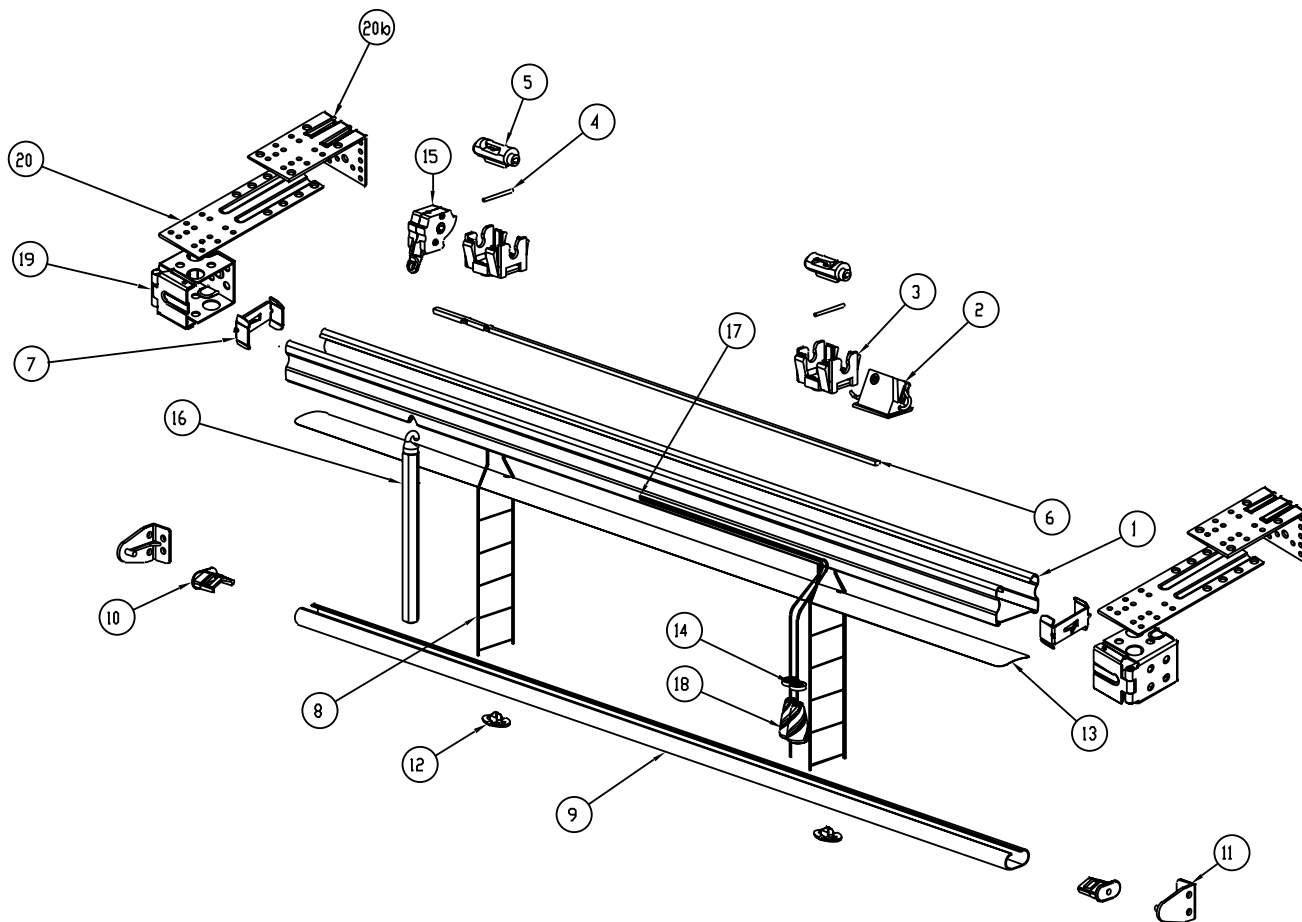

Monaco 6®

Item Number	Part Description	Part
1	HEADRAIL	RAHR0023
2	CORD LOCK	HMCL0032
3	CRADLE	HMCD0006
4	PIN, SIS CRADLE	HFPN0012
5	DRUM	HMDR0009
6	ROD	RRTE0010
7	END BRACE	HGEC0045
8	LADDER CORDS	T17Y0000
9	BOTTOMRAIL	K19B0300
10	END CAP, BOTTOMRAIL	DY038310
11	HOLD DOWN	E12F0000
12	LADDER CAP	Y23C0001
13	SLAT, 1" METAL	S71D0000
14	SAFETY CORD STOP	DDW30445
15	TILTER	HMTL0024
16	WAND	HGWN####
17	LIFT CORDS	C8800000
18	TASSEL	HGTS0001
19	BOX BRACKET	HBCK0109
20	EXTENSION BRACKET	HBEX0013
20b	EXTENSION BRACKET PLATE	HBEX0014
21	CENTER SUPPORT	HBCS0010

Terms and Conditions

Order Processing

Telephone Orders

Verbal orders are accepted as the dealer's responsibility. Each order will be repeated back by the Customer Service Representative. In certain instances, we may require written orders.

Duplicated Orders

All orders are confirmed after entry into our system. Customer Service is not responsible for duplicate orders caused by a written order following a telephone order or duplicate faxes.

Changes and Cancellations

All products are custom-made to your specifications under tight deadlines. Once production has begun on your order, changes and cancellations cannot be made.

Contract Orders

All Contract Orders must be processed through Contract Customer Service at 1-800-826-8021.

Freight

- Freight for custom blind orders within the continental U.S. will be prepaid. (Excludes Alaska and Hawaii)
- Shipments outside the continental U.S. are subject to freight charges.
- Chargeable parts and returns for repair are subject to freight charges.

Pricing and Terms

All prices are subject to change without notice. Until credit is approved, terms are cash with order. Standard terms are Net 30 days from invoice date.

Claims and Returns

Defective Merchandise

All manufacturing defects must be reported to Customer Service within 30 days of receipt of blinds. We may require the return of defective blinds prior to repair or replacement.

Incorrect Merchandise

If any part of your shipment was made incorrectly, please advise Customer Service within 30 days. A replacement will be made at no charge if the problem was due to Levolor® error. If the problem was due to dealer or customer error, the original order and replacement order will be full charge.

Returns for Repair

Prior to return for repair, contact Customer Service. We will request the order number, date, purchase order number, and type of product. Arrangements for return will be made at that time with directions as to how the blinds should be returned. The package should be marked for easy identification both inside and outside, and should contain a written confirmation of the verbal repair instructions. Repairs should be packaged carefully. Product that has been mishandled or received in poor condition will be returned to the customer.

Chargebacks for unauthorized repairs or additional installation cannot be honored. All returns for repair are subject to freight charges.

Returns for Credit

Returns can be accepted only if prior authorization has been obtained from Customer Service. Authorization will include instructions as to how the merchandise should be returned. Unauthorized returns will be refused.

Freight Damage FedEx /FedEx Ground/ Common Carrier:

If freight damage is visible, accept the freight, but sign for as damaged. Contact Customer Service immediately (must be notified within 14 days) for further information.

LIFETIME-LIMITED WARRANTY FOR CUSTOM PRODUCTS

Levolor® Window Fashions proudly extends a lifetime-limited warranty on the enclosed product to the original residential retail purchaser as long as the product remains in the original window.

<except for unfinished wood cornices, which have no warranty>.

WARRANTY COVERAGE

COVERED

Entire product against manufacturing defects (i.e., a flaw in the product design, materials or workmanship that causes the product to no longer function)

Except: Cords
Vertical vinyl vanes
All fabric

FOR HOW LONG

Lifetime
3 years
3 years
5 years

NOT COVERED

Normal wear and tear

Any product that fails due to:

- abuse
- accident
- alterations
- damage from pets/insects
- exposure to salt air
- extraordinary use
- improper cleaning
- improper handling
- improper installation
- improper operation
- misapplication
- misuse

Any product that, with the passage of time, has:

- loss of color intensity
- loss of pleating if product is not held in raised position a portion of the time
- yellowing or cracking of plastic parts or foam wood product

Any motorized product

Natural wood products that have:

- variations in color, grain, or texture
- warping of wood slats in high-humidity areas

Costs associated with:

- product removal
- product remeasure
- product reinstallation
- transportation to and from the retailer
- incidental or consequential damages
- shipping

In the event there are multiple blinds/shades in the same room, only the defective blind/shade will be replaced.

TO REPORT SHIPPING DAMAGE

If damage occurred during shipping, call 1-800-538-6567 and report within 14 calendar days or else you may be denied credit for your damaged product.

TO OBTAIN SERVICE



For online product-specific troubleshooting information, refer to www.levolor.com.



If you suspect this Levolor® Window Fashions product has a manufacturing defect in materials or workmanship:

1. Locate the sales receipt (proof of purchase).
2. Call 1-800-538-6567.

Any unauthorized returns will not be accepted.

WARRANTY REMEDY

THIS SHALL BE YOUR SOLE REMEDY UNDER THIS LIMITED WARRANTY.

If this Levolor® Window Fashions product is found to have a manufacturing defect in materials or workmanship, we will (at our discretion) do one of the following:

- repair the product
- replace the product
- refund the cost of the product
- Colors vary from lot to lot and may not exactly match sample swatch or previous purchases.
- Discontinued items or color selections will be replaced with the closest equivalent current product.

YOUR RIGHTS UNDER STATE LAW

This lifetime-limited warranty gives you specific legal rights, and you may have other rights, which vary from state to state. Some states do not allow limitations on how long a warranty lasts, so the above limitations may not apply to you.

No agent, representative, dealer, or unauthorized employee has the authority to increase or alter the obligation of this warranty. This lifetime-limited warranty supersedes any previous versions.

SAVE THIS WARRANTY CARD WITH YOUR PROOF OF PURCHASE

Account #: _____	Ship to: _____	Quote #: _____
Bill to:		PO #: _____
		Job Ref #: _____
	Phone #: _____	Order Date: _____ Req'd Date: _____
		Page 1 of: _____ Total Blinds: _____

CHECK ONE PRODUCT:

- | | |
|---|---|
| <input type="checkbox"/> Cordless Mark I | <input type="checkbox"/> Wood 1" |
| <input type="checkbox"/> Cordless Mark I 1 3/8" | <input type="checkbox"/> Cordless 2" Wood |
| <input type="checkbox"/> Mark I | <input type="checkbox"/> Wood 2" |
| <input type="checkbox"/> Mark I 1 3/8" | <input type="checkbox"/> Wood 2" Faux (PVC) |
| <input type="checkbox"/> Riviera® 1" Classic | <input type="checkbox"/> NuWood 2" Composite |
| <input type="checkbox"/> Riviera® 1/2" | <input type="checkbox"/> Wood 2 1/2" |
| <input type="checkbox"/> Riviera® 2" | <input type="checkbox"/> Wood 2 1/2" Faux (PVC) |
| <input type="checkbox"/> Riviera® Contract 1" | <input type="checkbox"/> Wood 3" |
| <input type="checkbox"/> Monaco® 6 | <input type="checkbox"/> Other |

OPTIONS:

- LightMaster™ (Mark I, Riviera 1", Monaco 6, Wood 2" and NuWood Faux Wood)
- SheerView (Mark I and Riviera 1")
- Restrictive Tilter (degrees: up/ down)
- Top-Lok Cord Lock
- Ring Pull (3" drop standard)
- Standard Valance Vogue Valance
- Tapes (2" only): Vinyl Twill (Color #)
- Tiltone Ladder
- OTHER:

	Special	Sidemark	QTY	Installation		Measurements		Control Positions			Ctrl Lgth	Sill Htgh	Hold Downs	COLOR	
				IB	OB	Width	Length	Cord Tilt	Tilt L/R	Lift L/R				#	Name
1.															
2.															
3.															
4.															
5.															
6.															
7.															
8.															
9.															
10.															

SPECIAL INSTRUCTIONS:

	<input type="checkbox"/>	BRACKETS
		Pre-Ship
		Pocket
		Pivot Plates (size=)
		Extension
CUSTOMER SIGNATURE		

Levolor Window Fashions ©2011
3 Glenlake Parkway, Atlanta, GA 30328
1-800-451-1111 • 1-800-232-9006 fax • www.levolor.com

NewellRubbermaid
Brands That Matter™

R0674010